



Broadview
Shading Solutions

TRADE PRICE LIST

(excluding VAT)



EXPERT

somfy.

BRUSTOR[®]
OUTDOOR SUN SYSTEMS

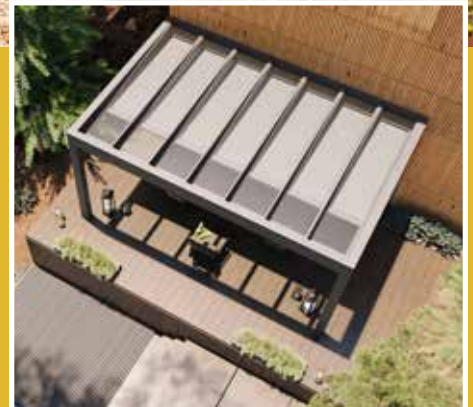

MARCH 2026

www.pergolasandshading.co.uk/trade

E & OE

Screenfabric Sergé 600 - Copaco

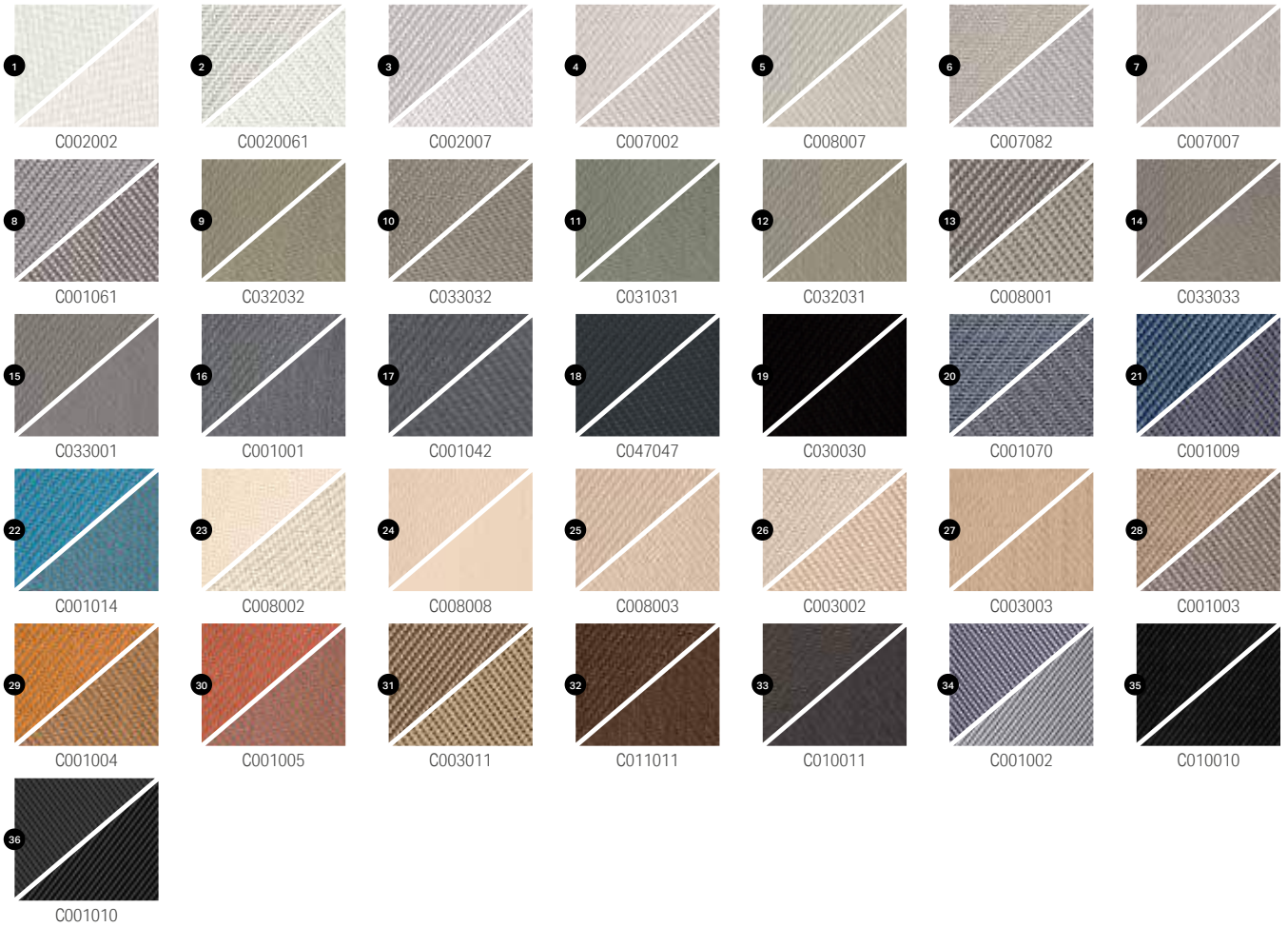

Screen Soltis Veozip - Serge Ferrari

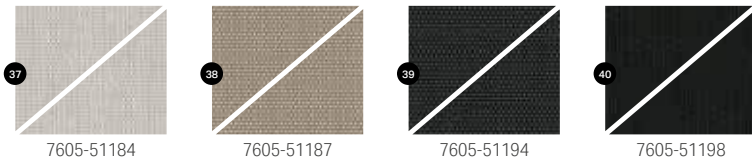

Roll width	References
2,70 m ^A	1 2 3 4 5 6 7 8 9 10 11 12 13 14 15 16 17 18 19 20 21 22 23 24 25 26 27 28 29 30 31 32 33
3,20 m ^B	1 2 3 4 6 7 8 9 14 15 16 17 18 19 20 21 22 23 24 26 28 34 35 36 37 38 39 40

































^A 2,70 m fabric is used for screens ≤ 2,50 m

^B 3,20 m fabric is used for screens ≤ 3,00 m

During the confection of stock fabrics Brustor always tries to limit the number of lanes. When the total width exceeds the roll width there is at least one seal.

Coupon fabrics (not stock fabrics) are only available in roll widths of 2,70 m, which means that there is a greater chance of welding and cutting seams.

Explanatory icon list

 Awnings	 Smartphone operation	 Passage height	 5 Number of years warranty
 Drop arm awnings	 Wall switch	 Sun sensor	 No warranty
 Screens	 Manual operation possible	 Wind sensor	 No warranty on folds formation and scratches
 Conservatory awnings / Pergola	 Wind force	 Rain and snow sensor	 Surcharge or price reduction
 Valance	 Max width	 LED	 Other sales conditions are valid (formerly *@)
 io control	 Max height	 Dimmable LED	 More info on page...
 Wired control unit	 Max width when coupled	 Heater	
 Brustor control	 Max projection	 Dimmable heater	
 Remote	 Inclination degree	 All RAL colours possible	

Trade Price March 2026 exc VAT.



General

- 3 Index
- 4 Fabric Collection

Awnings

- 6 Awnings overview
- 7 Technical specifications of inclination
- 8 B20
- 9 B50
- 10 B50S
- 11 B50 XL
- 12 B25 & 27
- 14 B24, B25 & B27 Elite
- 16 B24, B25 & B27 Prestige
- 18 Twinstor
- 19 B35 Elite
- 21 B35 Prestige
- 23 B38 Elite
- 24 B38 Prestige
- 25 Supplementary brackets & arms
- 26 Awning brackets - specials
- 29 Extra awning options

Conservatory Awnings

- 30 Conservatory awning & Pergola application limits
- 31 Topscreen
- 32 Topscreen coupled
- 33 Topscreen solar
- 34 B126 Conservatory awning
- 35 B126 Conservatory awning coupled
- 36 B127 Conservatory awning
- 37 B128 Conservatory awning
- 38 B129
- 39 B129 LED lighting
- 41 B128 Pergola
- 43 B128 LED lighting
- 44 B128 XL
- 48 B128 XL LED lighting

Stormproof awnings

- 49 B2100
- 51 B2100 2 parts: 3 arms

ZIP Screens

- 52 Screens overview
- 53 ZIP Screens profiles overview
- 54 ZIP Screens Application limits

- 55 B1085 ZIP
- 56 B1085 ZIP Coupled
- 57 B1100 ZIP
- 58 B1100 ZIP Coupled
- 59 B1100 ZIP Prestige
- 61 B1350 ZIP
- 66 B1100 ZIP SOLAR
- 67 B1100 ZIP Prestige SOLAR
- 68 B1350 ZIP SOLAR

Corner screen

- 71 B1100 ZIP Corner screen

Built-in Screen

- 73 B1200 ZIP Built-in screen
- 74 B1200 ZIP Built-in screen Coupled

Standard screens

- 75 Standard screens profiles overview
- 76 Standard screens Application limits
- 78 Indoor Screen

Windblocker

- 77 Windblocker

Accessories & Options

- 27 LED lighting
- 81 io Motors, sensors, transmitters
- 82 Patio heater
- 83 Technical information motors
- 84 WT Motors, sensors, transmitters
- 85 Price calculation for printing
- 87 Fabric covers
- 88 Screen covers
- 90 Paint set-up costs
- 91 Brustor Preferred List
- 94 Standard profiles
- 95 Minimal dimensions awnings
- 96 Umbrellas/Parasols/Outdoor living
- 105 Sliding glass wall systems
- 108 Merchandise, POS & Demo material
- 109 Terms and conditions/Warranty/Delivery Charges

Fabric Collection

Fabric class 1

Collection (roll width)Ⓐ	Fabric class 1	
Brustor Acryl Collection (1,20m)	Orchestra: 6020 / 6028 / 7330 / 7559 / 8203 / 8396 / 8904 / D113 / D306 / D308 / D319 / U905 / U137 / U140 / U171 / U335 / U343 / U370 / U371 / U406 U407 U408 / U413 Sattler: 314028 / 314030 / 314082 / 314154 / 314184 / 314325 / 314398 / 314402 / 314638 / 314840 / 314919 / 314941	Remark: Dickson Orchestra 6028 NOIR and Sattler 314154 BLACK are supplied with black stitching thread as standard. An additional cost of £50 net is charged automatically
Dickson Orchestra (1,20m)	Complete collection	Remark: Dickson Orchestra 6028 NOIR is supplied with black stitching thread as standard. An additional cost of £50 net is charged automatically
Sattler Elements Solid Serie 314 (1,20m)	314010 / 314020 / 314022 / 314028 / 314030 / 314070 / 314081 / 314082 / 314085 / 314154 / 314184 / 314325 / 314398 / 314402 / 314414 / 314471 314546 / 314638 / 314814 / 314819 / 314840 / 314851 / 314919 / 314941 314E67	Remark: Sattler 314154 BLACK is supplied with black stitching thread as standard. An additional cost of £50 net is charged automatically
Latim PVC 420 (2,20m)	Complete collection	Remark: sealed and waterproof Restriction: awning with a max projection of 3m Restriction: not in combination with transparent PVC
Latim PVC 650 (2,50m & 3,00m)	Complete collection (ref./01, /30 and /164 with height 3m on stock)	Remark: Sealed and waterproof Remark: No warranty on wrinkling Restriction: Only for screens Restriction: Up to 4,4m width Restriction: not in combination with transparent PVC
Cristal PVC (1,40cm)	On stock	Remark: Window max width of 5,00m. Remark: No warranty on wrinkling and scratches Restriction: Only for window in screen. Restriction: up to 4,4m width.
Soltis 86 (1,77m & 2,67m)	Roll width 1,77m: 2043 / 2044 / 2045 / 2047 / 2048 / 2053 / 2135 / 2148 / 2167 / 2171 / 2175 Roll width 2,67m: 2043 / 2044 / 2045 / 2047 / 2048 / 2135 / 2167 / 2171 / 2175 / 51176	Restriction: Up to 4,4m width / No warranty on wrinkling Remark: These references are on stock at Brustor, all the others belong to class 2.
Soltis 96 (1,20m)		Remark: Only for awnings.. Remark: No warranty on wrinkling . Restriction: Up to 7m width.
Soltis 96 (2,67m)		Remark: Also for screens. Remark: No warranty on wrinkling . Restriction: Up to 4,4m width. Restriction: Not for awnings.
Sergé 600 (Screenfabric) (1,60m - 3,20m) Overview on 2	Attention: modified codes for Sergé 600 Sergé 600: C001001 / C001002 / C001003 / C001010 / C001042 / C001061 / C002002 / C002007 / C002061 / C003002 / C003003 / C003011 / C007002 / C007007 / C008002 / C008008 / C010010 / C011011	Remark: The references Sergé 600 above are on stock. Coupon fabrics with other references with extra price < 60m² = +15% / ≥ 60m² = + 5% Restriction: Only for screens, not for Topscreen, awnings and conservatory awnings.
Sergé 600 (Screenfabric) (only roll width 2,70m and 3,20m) Overview on 2	Attention: modified codes for Sergé 600 Sergé 600: C001009 / C001014 / C001070 / C007082 / C030030 / C032032 / C033001 / C033033 / C047047	Remark: The references Sergé 600 above are on stock Coupon fabrics with other references with extra price < 60m² = +15% / ≥ 60m² = + 5% Restriction: Only for screens, not for Topscreen, awnings and conservatory awnings.
Sergé 600 (Screenfabric) (only roll width 2,70m) Overview on 2	Attention: modified codes for Sergé 600 Sergé 600: C001004 / C001005 / C008001 / C008003 / C008007 / C010011 / C031031 / C032031 / C033032	Remark: The references Sergé 600 above are on stock. Coupon fabrics with other references with extra price < 60m² = +15% / ≥ 60m² = + 5% Restriction: Only for screens, not for Topscreen, awnings and conservatory awnings.
Screen Soltis Veozip (only roll width 2,70m) Overview on 2	7605-51184 / 7605-51187 / 7605-51194 / 7605-51198	Remark: These references Veozip are on stock. No coupon fabrics. Restriction: Only for screens, not for Topscreen, awnings and conservatory awnings. ★ Fireclass M1

Ⓐ During the confection of stock fabrics Brustor always tries to limit the number of lanes. When the total width exceeds the roll width there is at least one seal. Acrylic textile is sewn using light grey Teflon wire, which provides the highest resistance

Collection (roll width)Ⓐ	Fabric in surcharge	
Sergé 600 Blockout LUNAR (2,1m) SOLAR (3,0m)	Complete collection	Important: Please mention the type of fabric (Lunar OR Solar)! Remark: Surcharge of £ 41/m² to screenfabric Remark: darkening Restriction: Max height 2,8m and 4m width Restriction: Not for awnings and Conservatory.
Soltis W96	Complete collection with a surcharge of £47/m² to fabric class 1.	Restriction: Up to 4.4m width. Restriction: Not for awnings and Conservatory.

Fabric class 2 & 3

Collection (roll width) [Ⓐ]	Fabric class 2	
Sattler Elements Solids Serie 314 (1,20m)	All Series 314 references that are not part of Fabric class 1.	
Sattler Elements Stripes Serie 320 (1,20m)	All Series 320 striped references	
Sattler Lumera (1,20m)	338639 / 338643 / 338644 / 338655 / 338662 / 338665	
Swela Elegance (1,20m - 2.5m)	Complete collection available	
Soltis 86 (1,77m - 2.67m)	All Soltis 86 references not listed in class 1.	Restriction: up to 4,4m width Remark: These are supplied as standard in 1.77m width. Optional in 2.67m width

Collection (roll width) [Ⓐ]	Fabric class 3	
Dickson Orchestra Max (1,20m)	All Dickson Orchestra Max references	Remark: standard glued instead of stitched: +£29 net / self-cleaning and water-resistant fabric Remark: Max 3 arms Restriction: Not for the B25, B27 and B24 series (Prestige, Elite and Standard)
Dickson Spark (1,20m)	SPARK U150 / SPARK U159 / SPARK U164 / SPARK U421 / SPARK U422 / SPARK U423 / SPARK U424 / SPARK U426 / SPARK U427	Remark: fabric with fire-retardant coating Remark: only stitched Remark: Max 2 arms / Max width 5m / Max projection 3,5m Restriction: Not for the B25, B27 and B24 series (Prestige, Elite and Standard)
Sattler Lumera All-Weather (1,20m)	All Sattler All Weather references	Remark: self-cleaning and water-resistant fabric Remark: can't be glued! B128
Swela Elegance Perla (1,20m)	On stock: 37008 / 37009 / 37018 / 37028 / 37037 / 37057	Remark: standard glued +£29 net (no surcharge of +£29 for B128) Restriction: not for B20 / B126 / B127 Restriction: max projection of 3,5m for awnings
Sergé 1% (2,7m)	Complete collection	Attention: please mention the type of fabric (Sergé 1%)
Soltis 92 (1,77m & 2.67m)	2043 / 2044 / 2045 / 2046 / 2047 / 2048 / 2051 / 2074 / 2135 / 2167 / 2171 / 2175 / 50265 / 50272 / 50850 / 2012 / 2068	Remark: the collection is on stock at Brustor Remark: no warranty on wrinkling Restriction: not for awnings Restriction: up to 4,4m width

[Ⓐ] During the confection Brustor always tries to limit the number of lanes. When the total width exceeds the roll width there is at least one seal.
Acrylic textile is sewn using light grey Teflow wire, which provides the highest resistance

Collection (roll width)	Fabric in surcharge			
Transparent PVC Cristal window	Transparent Cristal PVC in screens			Restriction: max height 1,21m / no possible with PVC 420 / PVC 650
	Height transparent window	1,21m	≤ 1,21m	
	Height window from the ground	0,90m	≠ 0,90m	
	Width screen till 3,00m	150 net	284 net	
	Width screen from 3,01 to 4,00m	191 net	378 net	
Additional costs	Width screen from 4,01 to 6,00m	331 net	567 net	+ £73 net + £41net + £29net → Not possible for acrylic fabrics on conservatory awnings → Not possible for B35 Elite fabrics > 7,5m → Not possible for B35 Elite with projection > 3.5m. → Not possible for coupled awnings → Not possible for B20
	Fabrics composed by two references Fabrics stitched with black Teflon instead of light grey Acrylic fabrics glued instead of sewn			

Awnings overview

	B20	B24 Elite	B24 Prestige	B25	B25 Elite	B25 Elite Valance	B25 Prestige	B25 Prestige Valance	B27	B27 Elite	B27 Prestige	B35 Elite	B35 Prestige	B38 Elite	B38 Prestige	B50	B50 S	B50 XL
100% closed box	✗	✓	✓	✓	✓	✓	✓	✓	✓	✓	✓	✗	✗	✗	✗	✓	✓	✓
Maximum width	5,5 m	7 m	7 m	7 m	7 m	6 m	7 m	6 m	7 m	7 m	7 m	7,5 m	7,5 m	6 m	6 m	5,5 m	5,5 m	6 m
Maximum width when coupled	✗	14 m	14 m	14 m	14 m	✗	14 m	✗	14 m	14 m	14 m	15 m	15 m	✗	✗	✗	✗	✗
Maximum projection	3 m	3,75 m	3,75 m	3 m	3,75 m	3 m	3,75 m	3 m	3 m	3,75 m	3,75 m	4 m	4 m	3,5 m	3,5 m	3 m	3 m	3,5 m
Number of arms	2	2-3 4-6	2-3 4-6	2-3 4-6	2-3 4-6	2-3	2-3 4-6	2-3	2-3 4-6	2-3 4-6	2-3 4-6	2-3 4-6	2-3 4-6	2-3	2-3	2	2	2
Standard arms (2 cables)	✓	✗	✗	✓	✗	✗	✗	✗	✓	✗	✗	✗	✗	✗	✗	✓	✓	✗
Elite arm (4 cables)	✗	✓	✗	✗	✓	✓	✗	✗	✗	✓	✗	✓	✗	✓	✗	✗	✗	✓
Prestige arm (4 cables)	✗	✗	✓	✗	✗	✗	✓	✓	✗	✗	✓	✗	✓	✗	✓	✗	✗	✗
Minimum inclination	5°	5°	5°	5°	5°	5°	5°	5°	5°	5°	5°	5°	5°	5°	5°	8°	8°	5°
Maximum inclination	40°	35°	35°	35°	35°	35°	35°	35°	35°	35°	35°	35°	35°	35°	35°	45°	45°	45°
Wall fixation	✗	✓	✓	✓	✓	✓	✓	✓	✓	✓	✓	✓	✓	✓	✓	✓	✓	✓
Ceiling fixation	✓	⊙	⊙	⊙	⊙	⊙	⊙	⊙	⊙	⊙	⊙	⊙	⊙	⊙	⊙	⊙	⊙	⊙
Standard number of RAL colours	1	5	all	5	5	5	all	all	5	5	all	5	all	5	all	5	4	5
Somfy motor for io	✓	✓	✓	✓	✓	✓	✓	✓	✓	✓	✓	✓	✓	✓	✓	✓	✓	✓
Somfyio motor with manual override	✗	⊙	⊙	⊙	⊙	⊙	⊙	⊙	⊙	⊙	⊙	⊙	⊙	⊙	⊙	⊙	✗	✗
Hand cranc (manual)	⊙	⊙	✗	⊙	⊙	✗	✗	✗	⊙	⊙	✗	⊙	✗	✗	✗	⊙	✗	✗
Led strip under box	✗	⊙	⊙	⊙	⊙	⊙	⊙	⊙	⊙	⊙	⊙	⊙	⊙	⊙	⊙	✗	✗	✗
Led strip in box	✗	✗	✗	✗	✗	✗	✗	✗	✗	✗	✗	✗	✗	✗	✗	✗	⊙	⊙
Led strip in arms	✗	⊙	⊙	✗	⊙	⊙	⊙	⊙	✗	⊙	⊙	⊙	⊙	⊙	⊙	✗	✗	⊙
Led spot in elbow	✗	✗	⊙	✗	✗	✗	⊙	⊙	✗	✗	⊙	✗	⊙	✗	⊙	✗	✗	✗
Motorised valance	✗	✗	✗	✗	✗	✓	✗	✓	✗	✗	✗	✗	✗	✓	✓	✗	✗	✗
Valance	⊙	⊙	⊙	⊙	⊙	✗	⊙	✗	⊙	⊙	⊙	⊙	⊙	✗	✗	⊙	⊙	⊙

Legend: ✓ standard / ⊙ option / ✗ not possible

Technical specifications of inclination

Determining the straight projection based on the height difference and arm length

Projection (U)	Inclination (H)							
		1500 mm	2000 mm	2500 mm	3000 mm	3500 mm	3750 mm	4000 mm
5°	V	131	174	218	261	305	327	349
	L	1494	1992	2490	2989	3487	3736	3985
10°	V	260	347	434	521	608	651	695
	L	1477	1970	2462	2954	3447	3693	3939
15°	V	388	518	647	776	906	971	1035
	L	1449	1932	2415	2898	3381	3622	3864
20°	V	513	684	855	1026	1197	1283	1368
	L	1410	1879	2349	2819	3289	3524	3579
25°	V	634	845	1057	1268	1479	1585	1690
	L	1359	1813	2266	2719	3172	3399	3625
30°	V	750	1000	1250	1500	1750	1875	2000
	L	1299	1732	2165	2598	3031	3248	3464
35°	V	860	1147	1434	1721	2008	2151	2294
	L	1229	1638	2048	2457	2867	3072	3277
40°	V	964	1286	1607	1928	2250	2410	2571
	L	1149	1532	1915	2298	2681	2873	3064
45°	V	1061	1414	1768	2121	2475	2652	2828
	L	1060	1414	1768	2122	2475	2651	2829

All dimensions are approximate. Download the Calculation sheet on MyBillie to calculate specific measurements.

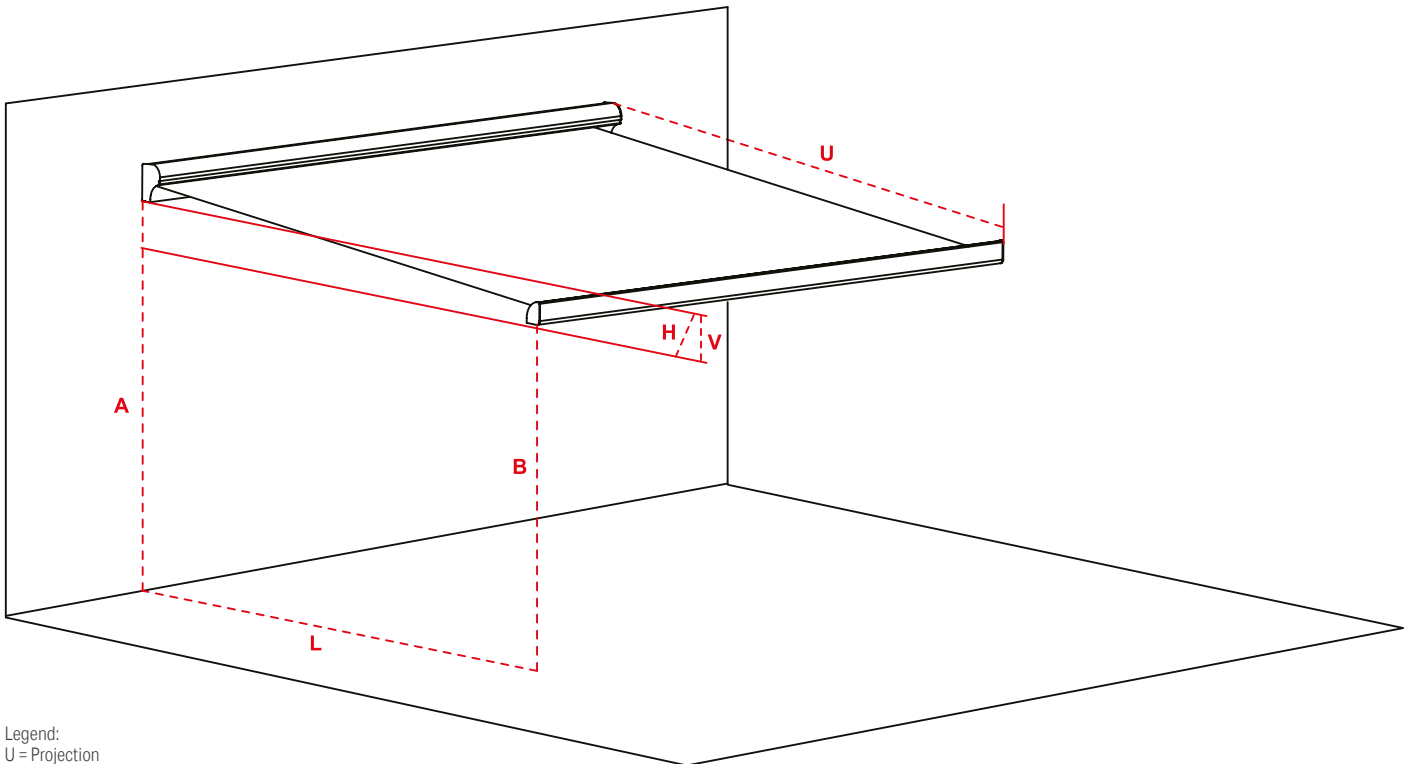

Legend:
 U = Projection
 H = Inclination angle
 A = Mounting height
 B = Passage height
 V = Height difference (A - B)
 L = Straight projection

Trade Price March 2026 exc VAT.



It is essential to mount the awning with a slope of 25cm/m projection

B20

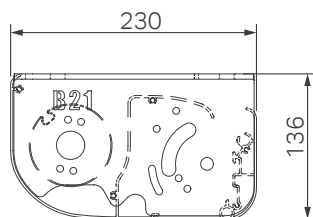
 ceiling fixation
 B20

Features

- B20 with inclination from 5° up to 40°
- Stitched fabrics only (no glued fabrics)
- Motor with manual override is not possible

Colours

Standard Colours



Other RAL-colours see table

 Brustor Preferred List
 91

Special finish

90

Options

- | | | |
|---|-------------------------------|----|
| 1 | Operation | 81 |
| 2 | Sensors | 81 |
| 3 | Heaters | 82 |
| 4 | Supplementary arms & brackets | 25 |
| 5 | Valance | 42 |



It is essential to mount the awning with a slope of 25cm/m projection

		Width	minimum width	2,5m	3m	3,5m	4m	4,5m	5m	5,5m
				2 arms + Sunea io + Situo 1 io						
1,5m	Fabric class 1	1,96m	1,96m	1682	1745	1789	1910	1960	2067	2155
	Fabric class 2			1745	1804	1848	1995	2043	2174	2257
	Fabric class 3			1794	1857	1899	2062	2109	2253	2341
	No fabric			1461	1529	1579	1648	1698	1750	1843
2,0m	Fabric class 1	2,48m	2,48m	1773	1821	1866	2011	2061	2175	2264
	Fabric class 2			1847	1894	1939	2108	2155	2296	2386
	Fabric class 3			1908	1958	2003	2188	2235	2399	2484
	No fabric			1504	1559	1608	1677	1729	1767	1866
2,5m	Fabric class 1	2,93m	2,93m		1893	1937	2086	2136	2281	2369
	Fabric class 2				1976	2019	2197	2245	2420	2508
	Fabric class 3				2049	2093	2293	2343	2541	2629
	No fabric				1575	1623	1680	1729	1783	1880
3,0m	Fabric class 1	3,40m	3,40m			2011	2178	2226	2394	
	Fabric class 2					2106	2301	2351	2547	
	Fabric class 3					2193	2414	2466	2687	
	No fabric					1648	1700	1755	1808	
Motor	Sunea io + Situo 1 io			included						
	Orea WT + switch			-131	-131	-131	-131	-131	-131	-131
	Lacq €298			164	174	188	200	212	224	238

 © Additional set-up cost of **€298** independently from dimensions or quantities. Trade Price March 2026 exc VAT.

B50

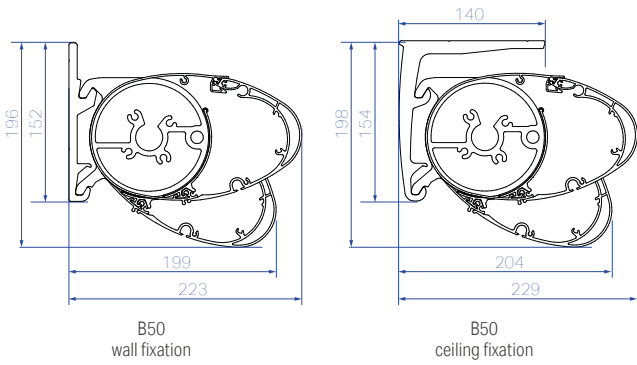

Features

- Awning with completely closed box.
- Can be fixated on the wall or on the ceiling.
- Max inclination of 45°.

Colours

Standard Colours

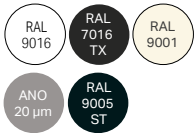

Other RAL-colours see table



Brustor Preferred List
 91

Special finish



Options

- 1 Operation 81
- 2 Sensors 81
- 3 Lighting 82
- 4 Heaters 82
- 5 Supplementary arms & brackets 25

Only for 2 arms

Gear with hand crank 1,4m instead of motor
 Hand crank 1,6m / 1,8m / 2,0m / 2,5m

Table
£ 18



It is essential to mount the awning with a slope of 25cm/m projection

		Width	minimum width	2,5m	3m	3,5m	3,65m	4m	4,5m	4,85m	5m	5,5m
				2 arms + Sunea io + Situo 1 io								
1,5m	Fabric class 1	1,78m	1,78m	1808	1863	1900	1955	1997	2041	2106	2155	2219
	Fabric class 2			1881	1937	1973	2071	2089	2132	2197	2275	2336
	Fabric class 3			1941	1995	2035	2163	2189	2208	2267	2367	2430
	No fabric			1528	1585	1628	1649	1680	1725	1756	1777	1843
2,0m	Fabric class 1	2,30m	2,30m	1875	1934	1971	2016	2085	2127	2182	2259	2324
	Fabric class 2			1971	2024	2065	2106	2201	2245	2297	2409	2472
	Fabric class 3			2045	2103	2139	2178	2296	2341	2389	2528	2590
	No fabric			1552	1610	1650	1662	1700	1751	1769	1802	1868
2,5m	Fabric class 1	2,73m	2,73m		1998	2037	2075	2167	2211	2258	2360	2420
	Fabric class 2				2110	2148	2183	2307	2352	2399	2538	2601
	Fabric class 3				2198	2235	2274	2421	2466	2509	2683	2745
	No fabric				1625	1664	1676	1716	1766	1781	1816	1883
3,0m	Fabric class 1	3,21m	3,21m			2103	2137	2249	2293	2338	2456	
	Fabric class 2					2229	2263	2413	2457	2501	2666	
	Fabric class 3					2335	2367	2549	2592	2635	2834	
	No fabric					1683	1686	1733	1778	1795	1832	
Motors	Sunea io + Situo 1 io						included					
	Orea WT+ switch			-131	-131	-131	-131	-131	-131	-131	-131	-131
	Gear			-479	-479	-479	-479	-479	-479	-479	-479	-479
Options	Without fabric protection profile			-33	-41	-49	-50	-54	-60	-65	-68	-76
	Lacq + £298			164	174	188	193	200	212	222	224	238

© Additional set-up cost of £298, independently from dimensions or quantities. Trade Price March 2026 exc VAT.

B50 S

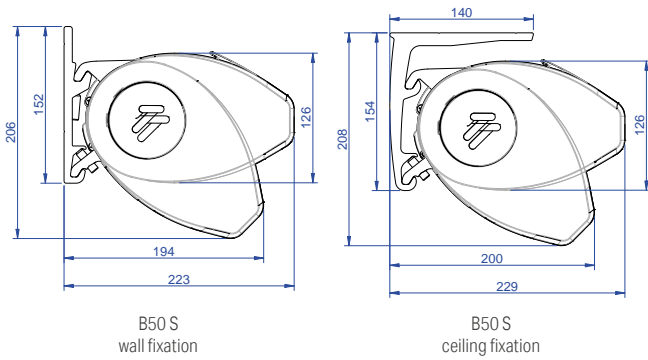

Features

- Awning with completely closed box.
- Standard version delivered with fabric protection profile.
- Can be fixated on the wall or on the ceiling.
- Max inclination of 45°.

Colours

Standard Colours

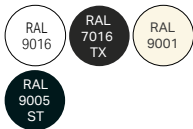

Other RAL-colours see table



Brustor Preferred List
91

Special finish



Options

- 1 Operation 81
- 2 Sensors 81
- 3 Lighting 27
- 4 Heaters 82
- 5 Supplementary arms & brackets 25



It is essential to mount the awning with a slope of 25cm/m projection

Projection		Width	minimum width	2,5m	3m	3,5m	3,65m	4m	4,5m	4,85m	5m	5,5m
				2 arms + Sunea io + Situio 1 io								
1,5m	Fabric class 1	1,90m	1901	1961	2000	2057	2100	2148	2217	2268	2336	
	Fabric class 2		1980	2039	2077	2180	2199	2244	2314	2394	2460	
	Fabric class 3		2043	2100	2144	2279	2304	2323	2387	2493	2557	
	No fabric		1609	1670	1714	1737	1770	1816	1848	1869	1940	
2,0m	Fabric class 1	2,42m	1973	2035	2075	2123	2195	2240	2297	2378	2447	
	Fabric class 2		2075	2130	2174	2217	2317	2364	2419	2536	2603	
	Fabric class 3		2152	2213	2252	2293	2418	2465	2514	2660	2726	
	No fabric		1633	1696	1737	1749	1789	1843	1862	1897	1967	
2,5m	Fabric class 1	2,85m		2104	2145	2183	2279	2326	2377	2484	2547	
	Fabric class 2			2221	2261	2299	2429	2475	2526	2673	2738	
	Fabric class 3			2315	2352	2392	2548	2595	2642	2825	2889	
	No fabric			1710	1751	1763	1806	1858	1874	1910	1981	
3,0m	Fabric class 1	3,33m			2213	2250	2366	2412	2462	2586		
	Fabric class 2				2347	2383	2540	2587	2634	2807		
	Fabric class 3				2457	2492	2683	2729	2772	2982		
	No fabric				1772	1775	1823	1871	1889	1928		
Motors	Sunea io + Situio 1 io		inbegrepen									
	Orea WT+ switch		-131	-131	-131	-131	-131	-131	-131	-131	-131	
	Lacq + £298		164	174	188	200	200	212	224	238	251	

A Control always externally B Control integrated in roller tube C Additional set-up cost of £298, independently from dimensions or quantities. Trade Price March 2026 exc VAT.

B50 XL

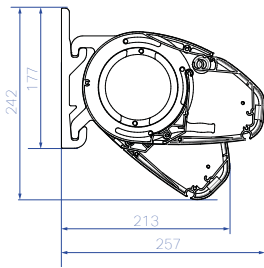

B50XL
wall fixation

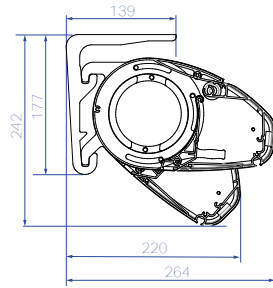

B50XL
ceiling fixation

Colours

Standard Colours

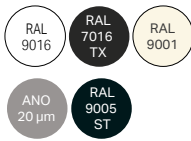

Other RAL-colours see table



Brustor Preferred List
91

Special finish

90

Features

- Awning with completely closed box.
- Standard version delivered with fabric protection profile.
- Can be fixated on the wall or on the ceiling.
- Max inclination of 45°.

Options

- 1 Operation 81
- 2 Sensors 81
- 3 Lighting 27
- 4 Heaters 82
- 5 Supplementary arms & brackets 25



It is essential to mount the awning with a slope of 25cm/m projection

Width		minimum width	2,5m	3m	3,5m	4m	4,5m	5m	5,5m	6m
			2 arms + Sunea io + Situo 1 io							
1,5m	Fabric class 1	1,91m	1922	2023	2124	2289	2393	2498	2602	2760
	Fabric class 2		1967	2077	2189	2367	2482	2596	2711	2881
	Fabric class 3		2005	2123	2242	2430	2552	2676	2798	2978
	No fabric		1680	1755	1830	1960	2035	2113	2189	2312
2,0m	Fabric class 1	2,43m	1970	2077	2186	2361	2472	2583	2696	2864
	Fabric class 2		2028	2150	2270	2461	2583	2708	2832	3015
	Fabric class 3		2075	2205	2336	2538	2673	2806	2943	3139
	No fabric		1697	1772	1846	1974	2051	2130	2205	2328
2,5m	Fabric class 1	2,86m	2130	2244	2428	2547	2664	2784	2960	
	Fabric class 2		2215	2345	2547	2681	2816	2949	3146	
	Fabric class 3		2284	2426	2642	2789	2935	3082	3294	
	No fabric		1782	1857	1987	2064	2140	2217	2339	
3,0m	Fabric class 1	3,34m			2312	2505	2630	2756	2881	3069
	Fabric class 2				2429	2643	2788	2932	3075	3286
	Fabric class 3				2523	2756	2913	3073	3231	3457
	No fabric				1878	2007	2085	2161	2239	2361
3,5m	Fabric class 1	3,85m				2590	2723	2855	2988	
	Fabric class 2				2748	2903	3057	3211		
	Fabric class 3				2879	3048	3219	3389		
	No fabric				2037	2114	2190	2268		
Motors	Sunea io + Situo 1 io		included							
	Orea WT + switch		-131	-131	-131	-131	-131	-131	-131	-131
	Lacq + £298		164	174	188	200	212	224	238	251

Control always externally Control integrated in roller tube Additional set-up cost of **£298**, independently from dimensions or quantities. Trade Price March 2026 exc VAT.

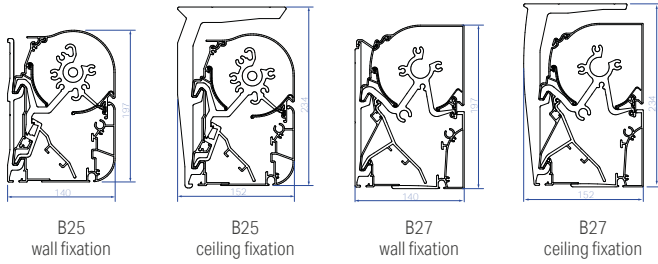

Features

- Width: 2,05m - 7,0m (coupled: 14m)
Projection: 1,5m - 3,0m

Colours

Standard Colours

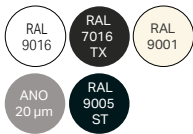

Other RAL-colours see table



Brustor Preferred List
91

Special finish 90



		Width	mini- mum width when 2 arms	2,5m	3,0m	3,5m	4,0m	4,5m	4,8m	5,0m	5,5m	mini- mum width when 3 arms	6,0m [ⓑ]	6,5m	7,0m [ⓓ]
				2 arms + Sunea io + Situo 1 io									3 arms + Sunea io + Situo 1 io		
1,5m	Fabric class 1	2,03m	1716	1837	1929	2085	2182	2253	2314	2430	3,05m	2834	2970	3012	
	Fabric class 2			1746	1883	1971	2140	2243	2302	2384		2501	2906	3057	3083
	Fabric class 3 [ⓔ]			1775	1923	2013	2198	2297	2358	2456		2571	2976	3146	
	No fabric			⁹⁵ 1617	1685	1797	1888	1995	2072	2072		2163	⁹⁵ 2656	2763	2778
2,0m	Fabric class 1	2,55m		1926	2066	2201	2341	2364	2438	2558	3,85m	2974	3131	3166	
	Fabric class 2			1981	2121	2268	2408	2431	2534	2654		3068	3242	3257	
	Fabric class 3 [ⓔ]			2037	2177	2336	2474	2504	2627	2746		3102	3357		
	No fabric			⁹⁵ 1738	1845	1944	2053	2124	2124	2212		⁹⁵ 2716	2850	2890	
2,5m	Fabric class 1	2,98m		2018	2155	2305	2454	2483	2576	2697	4,48m	3126	3305	3336	
	Fabric class 2			2087	2226	2398	2544	2566	2688	2810		3242	3444	3486	
	Fabric class 3 [ⓔ]			2152	2293	2485	2635	2654	2804	2925		3362	3586		
	No fabric			⁹⁵ 1777	1883	1974	2093	2163	2163	2250		⁹⁵ 2790	2896	2932	
3,0m	Fabric class 1	3,46m		2231	2454	2552	2641	2751	2833	5,17m	3292	3526	3565		
	Fabric class 2			2314	2559	2661	2734	2884	2968		3432	3693	3722		
	Fabric class 3 [ⓔ]			2393	2666	2770	2841	3019	3103		3572	3859			
	No fabric			⁹⁵ 1926	2022	2134	2205	2205	2295		⁹⁵ 2846	2966	3000		
Motor	Sunea io + Situo 1 io			Included									included		
	Sunea CSI + Situo 1 io		66	66	66	66	66	66	66	66					
	Orea WT + switch		-131	-131	-131	-131	-131	-131	-131	-131		-135	-135	-135	
	NHK + Switch		31	31	31	31	31	31	31	31		30	30	30	
	Gear		-479	-479	-479	-479	-479	-479	-479	-479					
Options	Eolis 3D RTS / io sensor [ⓔ]		135	135	135	135	135	135	135	135		135	135	135	
	Lacc [ⓔ] + £298 [ⓓ]		164	174	188	200	212	220	224	238		299	311	321	

[ⓑ] B25 Also the cost to be deducted for 2 arms instead of 3 for a width between 5,501m and 6m [ⓔ] Additional set-up cost of £298, independently from dimensions or quantities [ⓓ] 7m standard in one part: recommended with 4 arms. Trade Price March 2026 exc VAT.

B25 & B27

Options

- 1 Operation 81
- 2 Sensors 81
- 3 Lighting 27
- 4 Heaters 82
- 5 Supplementary arms & brackets 25
- 6 Valance 42
- 7 Integrated lead rail support 42

Only for 2 arms

Gear with hand crank 1,4m instead of motor
Hand crank 1,6m / 1,8m / 2,0m / 2,5m











Table
£ 18

Ceiling brackets per width

Width	5 cm	10 cm
2,05 - 4,00	1	2
4,01 - 5,50	3	2
5,51 - 6,00	2	3
6,01 - 7,00	3	3
7,01 - 8,00	2	5
8,01 - 12,00	4	5
12,01 - 14,00	4	7

Number of wall brackets

2 x 300	2 x 500 1 x 100	2 x 500 1 x 300	2 x 500 1 x 300 1 x 100	1 x 1000 2 x 300	2 x 500 1 x 1000 2 x 100	2 x 500 1 x 1000 2 x 300
---------	--------------------	--------------------	-------------------------------	---------------------	--------------------------------	--------------------------------

minimum width when 4 arms	8,0m	9,0m	9,5m	10m	11m	12m	minimum width when 6 arms	12m	13m	14m
	4 arms  + Sunea io + Situ 1 io							6 arms  + Sunea io + Situ 1 io		
4,50m With LEDs: 	3826	4081	4162	4272	4525	4853	7,10m With LEDs: 	5547	5637	5897
	3941	4196	4266	4416	4667	4997		5666	5817	6039
	4058	4311	4376	4561	4814	5143		5812	6026	
	3591	3809	3957	3957	4139	4419		5198	5414	5467
	4107	4396	4433	4574	4788	5143		5801	5990	6209
5,60m With LEDs: 	4246	4532	4567	4761	4979	5328	8,60m With LEDs: 	5987	6194	6388
	4381	4669	4713	4951	5165	5519		6078	6460	
	3706	3926	4076	4076	4234	4520		5318	5585	5691
	4310	4611	4651	4825	5070			5981	6345	6545
6,50m With LEDs: 	4493	4799	4815	5056	5300		9,90m With LEDs: 	6224	6631	6846
	4678	4982	4994	5288	5532			6463	6929	
	3774	3988	4155	4155	4320			5468	5679	5774
	4517	4828	4888	5093	5345			6321	6800	
7,32m With LEDs: 	4735	5047	5081	5365	5616		10,82m With LEDs: 	6607	7137	
	4954	5269	5296	5638	5890			6898	7490	
	3859	4077	4241	4241	4406			5577	5815	
	Included							Included		
	-135	-135	-135	-135	-135	-135		-146	-146	-146
	40	40	40	40	40	40		12	12	12
	132	132	132	132	132	132		132	132	132
	384	408	419	431	454	479		575	600	624



It is essential to mount the awning with a slope of 25cm/m projection

B24, B25 & B27 Elite

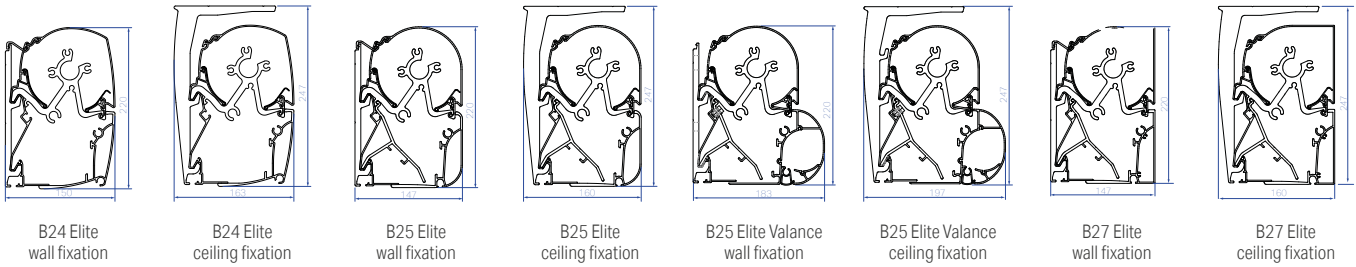

Colours

Standard Colours

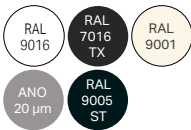

Other RAL-colours see table



Brustor Preferred List
91

Special finish



												B25		
Projection	Width	minimum width when 2 arms	2,5m	3,0m	3,5m	4,0m	4,5m	4,8m	5,0m	5,5m	minimum width when 3 arms	6,0m	6,5m	7,0m
			2 arms + Sunea io + Situio 1 io									3 arms + Sunea io + Situio 1 io		
1,5m	Fabric class 1	2,05m With Leds: 95	1817	1951	2047	2218	2324	2400	2464	2590	3,05m With Leds: 95	3018	3163	3211
	Fabric class 2		1848	1997	2097	2278	2388	2456	2541	2664		3095	3262	3287
	Fabric class 3 ^E		1881	2044	2142	2341	2448	2512	2618	2746		3176	3356	3538
	No Fabric		1716	1783	1909	2007	2124	2210	2210	2303		2826	2943	2956
2,0m	Fabric class 1	2,57m With Leds: 95		2046	2197	2345	2496	2517	2603	2732	3,85m With Leds: 95	3167	3337	3379
	Fabric class 2		2104	2256	2414	2569	2591	2703	2833	3271		3460	3474	
	Fabric class 3 ^E		2163	2319	2493	2641	2672	2805	2935	3309		3577	3587	
	No Fabric		1804	1930	2028	2145	2230	2230	2324	2887		3035	3079	
2,5m	Fabric class 1	3,00m With Leds: 95	2146	2293	2459	2617	2651	2750	2881		4,48m With Leds: 95	3335	3526	3561
	Fabric class 2		2220	2370	2556	2718	2737	2873	3007	3460		3681	3706	
	Fabric class 3 ^E		2292	2444	2654	2816	2833	2998	3131	3590		3833	3899	
	No Fabric		1886	1998	2103	2226	2303	2303	2400	2972		3086	3124	
3,0m	Fabric class 1	3,49m With Leds: 95		2376	2617	2724	2821	2940	3027		5,25m With Leds: 95	3517	3770	3813
	Fabric class 2		2464	2734	2843	2923	3085	3178	3668	3951		3984		
	Fabric class 3 ^E		2552	2852	2963	3039	3232	3324	3818	4132		4161		
	No Fabric		2048	2152	2271	2349	2349	2448	3031	3161		3198		
3,5m	Fabric class 1	4,00m With Leds: 95				2760	2842	2915	3053	3139	6,00m With Leds: 95	3753	4006	4108
	Fabric class 2		2891	2961	3014	3196	3287	3903	4188	4287				
	Fabric class 3 ^E		3002	3075	3119	3342	3431	4055	4365	4439				
	No Fabric		2278	2407	2486	2486	2581	3291	3420	3458				
3,75m	Fabric class 1	4,25m With Leds: 95					2902	2982	3117	3205	6,39m		4088	
	Fabric class 2		3017	3079	3262	3352	4269							
	No Fabric		2474	2559	2559	2650	3512							
Motor	Sunea io + Situio 1 io		included									included		
	Sunea CSI + Situio 1 io ^F		66	66	66	66	66	66	66	66		included		
	Orea WT + switch		-131	-131	-131	-131	-131	-131	-131	-131		-135	-135	-135
	NHK + switch ^F		31	31	31	31	31	31	31	31		30	30	30
	Gear		-479	-479	-479	-479	-479	-479	-479	-479				
Ceiling brackets		150	150	150	150	212	212	212	212		239	239	284	
Valance with motor	Soltis 86	1,5m	856	901	970	1002	1069	1103	1103	1170		1211		
	Soltis 92 or 96	1,5m	877	956	1033	1076	1150	1192	1192	1268		1320		
	Sunea io		included									included		
	LT motor + switch		-126	-126	-126	-126	-126	-126	-126	-126		-126		
Laq ^C + £193 ^B		168	179	194	204	217	225	230	243		306	319	329	

^B B25 Elite Also the cost to be deducted for 2 arms instead of 3 for a width between 5,51m and 6m (max 3,5m projection) ^C Additional set-up cost of £193, independently from dimensions or quantities
^D 7m standard in one part: recommended with 4 arms ^E Dickson Orchestra Max not possible → alternative with Swela Elegance Perla or Sattler All-Weather
^F If NHK motor or Somfy Sunea CSI io, then minimum dimension + 50mm. Trade Price March 2026 exc VAT.

Options

- 1** Operation 📖 81
- 2** Sensors 📖 81
- 3** Lighting 📖 27
- 4** Heaters 📖 82
- 5** Integrated lead rail support 📖 42
- 6** Supplementary arms & brackets 📖 25

Ceiling brackets per width

Width	5 cm	10 cm
2,05 - 4,00	1	2
4,01 - 5,50	3	2
5,51 - 6,00	2	3
6,01 - 7,00	3	3
7,01 - 8,00	2	5
8,01 - 12,00	4	5
12,01 - 14,00	4	7

Only for 2 arms

Gear with hand crank 1,4m instead of motor
Hand crank 1,6m / 1,8m / 2,0m / 2,5m

Table
£18

Number of wall brackets

2 x 300	2 x 500 1 x 100	2 x 500 1 x 300	2 x 500 1 x 300 1 x 100	1 x 1000 2 x 300	2 x 500 1 x 1000 2 x 100	2 x 500 1 x 1000 2 x 300
---------	--------------------	--------------------	-------------------------------	---------------------	--------------------------------	--------------------------------

	minimum width when 4 arms	8,0m	9,0m	9,5m	10m	11m	12m	minimum width when 6 arms	12m	13m	14m
		4 arms + Sunea io + Situio 1 io							6 arms + Sunea io + Situio 1 io		
1,5m	4,50m With Leds: 📖 95	4089	4366	4455	4576	4847	5207	7,10m With Leds: 📖 95	5915	6045	6307
		4217	4494	4569	4730	5006	5364		6045	6244	6462
		4343	4619	4689	4889	5163	5522		6206	6468	6957
2,0m	5,60m With Leds: 📖 95	3835	4070	4236	4307	4407	4715	8,60m With Leds: 📖 95	5540	5773	5837
		4397	4712	4751	4903	5136	5522		6189	6433	6646
		4548	4860	4893	5108	5342	5725		6396	6654	6834
2,5m	6,50m With Leds: 📖 95	4696	5007	5056	5311	5546	5928	9,90m With Leds: 📖 95	6472	6940	7043
		3963	4203	4362	4433	4533	4842		5792	5959	6081
		4616	4944	4987	5176	5442	0		6495	6871	7076
3,0m	7,48m With Leds: 📖 95	4815	5144	5166	5426	5691	0	10,82m With Leds: 📖 95	6750	7167	7339
		5014	5345	5360	5676	5943	0		6945	7497	7626
		4032	4268	4449	4520	4628	0		5622	6063	6170
3,5m	8,48m With Leds: 📖 95	4842	5181	5245	5467	5737	0	12,35m	6798	7310	7508
		5081	5416	5452	5761	6036	0		7104	7678	7844
		5317	5656	5686	6062	6334	0		7419	8057	8209
3,75m	8,93m With Leds: 📖 95	4129	4364	4541	4611	4721	0		5951	6212	6318
		0	5504	5533	5784	6172	0		0	7903	0
		0	5741	5782	6086	6467	0		0	8263	0
Motor		0	5976	6018	6380	6756	0		0	8620	0
		0	4718	4893	4965	5089	0		0	6762	0
		0	5620	5643	5918	0	0				
Valance with motor		0	5853	5882	6216	0	0				
		0	4842	5043	5359	0	0				
			included							included	
		-138	-138	-138	-138	-138	-138		-151	-151	-151
		41	41	41	41	41	41		12	12	12
		299	386	386	386	386	386		522	522	522
		395	419	431	446	468	494		593	618	643

B24, B25 & B27 Prestige

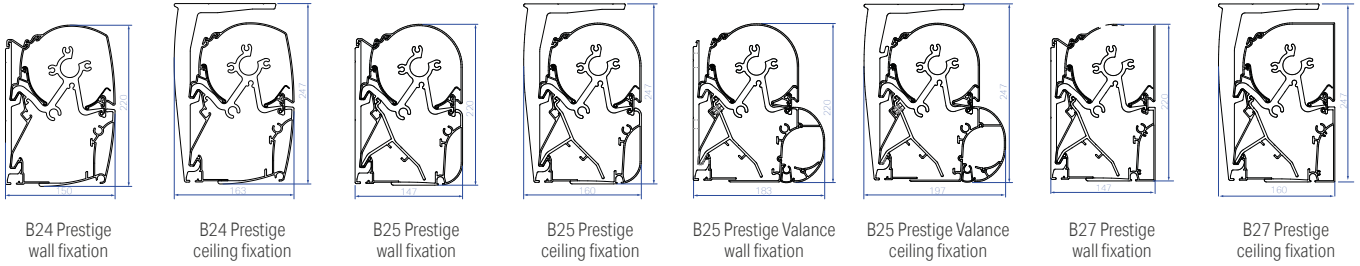

Colours

Standard Colours

Brustor Preferred List

Special finish



91

90

all RAL standard

		Width	minimum width when 2 arms	3,5m	4,0m	4,5m	4,8m	5,0m	5,5m	minimum width when 3 arms	6,0m ^B	6,5m	7,0m ^D
Projection				2 arms + Sunea io + Situio 1 io							3 arms + Sunea io + Situio 1 io		
3,0m	Fabric class 1	3,49m	With Leds: ⁹⁵	2616	2887	3006	3116	3247	3348	5,25m	3892	4175	4224
	Fabric class 2			2713	3016	3142	3228	3412	3513		4060	4377	4416
	Fabric class 3 ^E			2811	3148	3271	3357	3577	3678		4230	4583	4614
	No Fabric			2300	2434	2568	2658	2677	2786		3428	3593	3635
3,5m	Fabric class 1	4,03m	With Leds: ⁹⁵			3140	3221	3375	3473	6,00m	4155	4442	4557
	Fabric class 2			3271	3331	3537	3638	4350	4644		4756		
	Fabric class 3 ^E			3400	3450	3701	3798	4545	4845		4926		
	No Fabric			2721	2807	2828	2931	3828	3883		3935		
3,75m	Fabric class 1	4,25m	With Leds: ⁹⁵			3289	3380	3539	3641	6,39m		4656	
	Fabric class 2			3420	3495	3705	3809		4866				
	No Fabric			2787	2887	2887	2994		3984				
Motor	Sunea io + Situio 1 io			included							included		
	Sunea CSI + Situio 1 io ^F			66	66	66	66	66	66				
	NHK + switch ^F			157	157	157	157	157	157		157	157	157
	Orea WT + switch			-131	-131	-131	-131	-131	-131		-135	-135	-135
Ceiling brackets				150	150	212	212	212	212		239	239	284
Valance with motor	Soltis 86	1,5m		970	1002	1069	1103	1103	1170		1211		
	Soltis 92 or 96	1,5m		1033	1076	1150	1192	1192	1268		1320		
	Sunea io			included									
	Lacq ^G			included							included		

^A Additional arm possible from 5,24m (5,44m with LED's) ^B B25 Prestige Also the cost to be deducted for 2 arms instead of 3 for a width between 5,51m and 6m (max 3,5 m projection) ^C No lacquer costs for B24 Prestige, B25 Prestige & B27 Prestige in Brustor Preferred List RAL colours. ^D 7m standard in one part: recommended with 4 arms ^E Dickson Orchestra Max not possible → alternative with Swela Elegance Perla or Sattler All-Weather ^F If NHK motor or Somfy Sunea CSI io, then minimum dimension + 50mm.

Options

- 1 Operation 81
- 2 Sensors 81
- 3 Lighting 27
- 4 Heaters 82
- 5 Integrated lead rail support 42
- 6 Supplementary arms & brackets 25

Ceiling brackets per width

Width	5 cm	10 cm
2,05 - 4,00	1	2
4,01 - 5,50	3	2
5,51 - 6,00	2	3
6,01 - 7,00	3	3
7,01 - 8,00	2	5
8,01 - 12,00	4	5
12,01 - 14,00	4	7

Number of wall brackets

2 x 300	2 x 500 1 x 100	2 x 500 1 x 300	2 x 500 1 x 300 1 x 100	1 x 1000 2 x 500	2 x 500 1 x 1000 2 x 100	2 x 500 1 x 1000 2 x 300
---------	--------------------	--------------------	-------------------------------	---------------------	--------------------------------	--------------------------------

	minimum width when 4 arms	8,0m	9,0m	9,5m	10m	11m	minimum width when 6 arms	12m	13m	14m
		4 arms + Sunea io + Situo 1 io						6 arms + Sunea io + Situo 1 io		
3,0m	7,48m With Leds: 95	5376	5754	5827	6075	6380	10,84m With Leds: 95	7556	8137	8720
		5642	6019	6062	6408	6715		7900	8552	9204
		5906	6288	6323	6744	7050		8252	8975	9695
		4696	4975	5161	5290	5407		6366	6687	7007
3,5m	8,48m With Leds: 95		6119	6223	6435	6795	12,44m With Leds: 95		9125	
			6380	6459	6772	7128			9546	
			6629	6718	7105	7447			9964	
3,75m	8,93m With Leds: 95		5370	5552	5658	5659		7793		
			6422	6447	6768					
Motor		included						included		
		168	168	168	168	168		139	139	139
Valance with motor		-138	-138	-138	-138	-138		-151	-151	-151
		299	386	386	386	386		522	522	522
included								included		

Twinstor

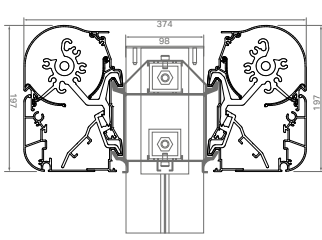

Twinstor B25

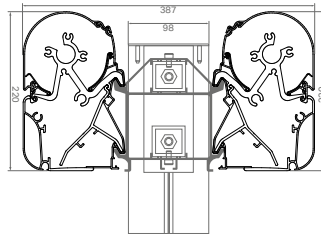

Twinstor B25 Elite

Features

- Stand-alone structure with 2 awnings.
- Width up to max 7m / Projection: 2 x 2m up to 2 x 3m
- Standard version delivered with 2 concrete ground anchors.
- Awnings: 2 x B25 or 2 x B25 Elite
- Standard height: 275cm

Colours frame

Standard Colours



Other RAL-colours see table



Brustor Preferred List
91

Special finish 90



Colours awnings

Standard Colours



Other RAL-colours see table



Brustor Preferred List
91

Special finish 90



Options

- 1 Operation
- 2 Sensors
- 3 Lighting
- 4 Heaters
- 5 Supplementary arms & brackets
- 6 Valance

	Width	Projection	2 arms + Sunea io + Situo 1 io + concrete ground anchors								3 arms + Sunea io + Situo 1 io + concrete ground anchors		Surcharge floor plates + flowerboxes ^A
			3,5m	4m	4,5m	4,8m	5m	5,5m	6,0m	6,5m	7m		
Price 2 x B25 zonder frame	2 x 2m	Fabric class 1	4079	4347	4630	4673	4822	5064	5895	6207	6281	1128	
		Fabric class 2	4191	4484	4763	4808	5015	5253	6081	6432	6459	1128	
		Fabric class 3	4300	4619	4896	4953	5201	5438	6151	6661		1128	
	2 x 2,5m	Fabric class 1	4257	4556	4855	4912	5100	5342	6200	6557	6619	1128	
		Fabric class 2	4400	4742	5033	5076	5325	5568	6432	6837	6919	1128	
		Fabric class 3	4533	4917	5215	5253	5556	5796	6667	7119		1128	
	2 x 3m	Fabric class 1	4407	4855	5052	5229	5449	5614	6530	7000	7077	1128	
		Fabric class 2	4572	5066	5269	5414	5714	5883	6809	7332	7388	1128	
		Fabric class 3	4733	5282	5488	5627	5987	6151	7089	7663		1128	
Surcharge B25 Elite	2 x 2m	Fabric class 1	265	288	311	311	332	350	388	416	428	1128	
		Fabric class 2	269	296	322	322	341	361	410	439	437	1128	
		Fabric class 3	285	312	334	339	359	380	414	441		1128	
	2 x 2,5m	Fabric class 1	279	308	328	339	348	371	418	445	453	1128	
		Fabric class 2	291	318	350	345	371	393	439	472	441	1128	
		Fabric class 3	302	339	365	361	388	412	461	494		1128	
	2 x 3m	Fabric class 1	292	328	345	361	382	388	453	490	497	1128	
		Fabric class 2	305	350	366	377	405	420	476	517	527	1128	
		Fabric class 3	318	371	387	398	425	445	497	548		1128	
	Surcharge frame			1641	1704	1758	1792	1817	1875	1937	1994	2052	
	Motor	2 x Sunea io + Situo 1 io	included										
		2 x Orea WT + switch	-208	-208	-208	-208	-208	-208	-208	-217	-217	-217	
Colour	Awning ^C + £298 ^B	366	387	413	426	435	461	580	605	626			
	Frame ^C + £298 ^B	86	93	99	101	104	113	119	125	134			
	2 Flowerboxes + £298 ^B	116	116	116	116	116	116	116	116	116	116		

^A Flowerboxes standard in grey RAL 9007 textured ^C Additional set-up cost of £298 per identical colour for the awning and the frame / £360 with different colours ^B Price reduction if combination of both LED strips on one controller (Somfy io dimmable 4 channels / max 12m)

B35 Elite

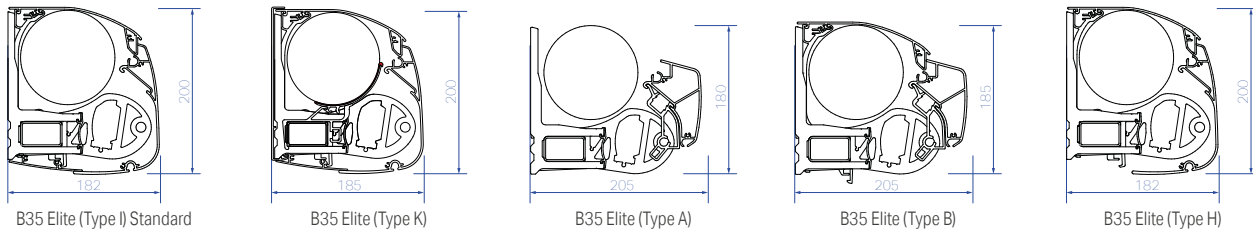

Colours

Standard Colours

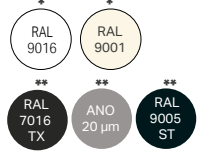

* type A, B, H, I, K
** type H, I, K

Other RAL-colours see table



Brustor Preferred List
97

Special finish 90



Features

- Awning with tube system and open / semi-closed / closed box.
- 5 Beaufort
- Fabric in 1 part possible with coupled awnings.

Width	minimum width when 2 arms	2,5m	3m	3,5m	4m	4,5m	5m	5,5m	6m	minimum width when 3 arms	6,5m	7m	7,5m [ⓐ]	
		2 arms + Sunea io + Situo 1 io									3 arms + Sunea io + Situo 1 io			
1,5m	Fabric class 1	2,05m	2093	2168	2264	2420	2592	2780	2891	3040	3,05m	3545	3669	3874
	Fabric class 2	With Leds: 95	2132	2210	2305	2474	2650	2848	2954	3119	With Leds: 95	3624	3744	3973
	Fabric class 3		2183	2258	2357	2540	2714	2930	3042	3218		3723	3836	4084
	No Fabric		1880	1964	2068	2156	2319	2440	2557	2642		3221	3350	3502
2,0m	Fabric class 1	2,57m		2240	2338	2509	2686	2890	3001	3164	3,85m	3682	3804	4027
	Fabric class 2	With Leds: 95		2293	2389	2578	2755	2976	3084	3267	With Leds: 95	3784	3898	4149
	Fabric class 3			2356	2451	2661	2838	3077	3187	3388		3908	4011	4283
	No Fabric			1981	2085	2175	2336	2459	2579	2661		3251	3388	3540
2,5m	Fabric class 1	3,00m		2314	2405	2601	2776	2998	3112	3452	4,48m	3820	3935	4169
	Fabric class 2	With Leds: 95		2378	2468	2683	2860	3102	3213	3576	With Leds: 95	3942	4049	4319
	Fabric class 3			2451	2544	2783	2960	3224	3335	3721		4088	4184	4485
	No Fabric			2003	2100	2196	2358	2480	2596	2863		3281	3417	3573
3,0m	Fabric class 1	3,50m			2511	2718	2894	3137	3245	3626	5,49m	3996	4072	4324
	Fabric class 2	With Leds: 95			2585	2817	2990	3255	3364	3769	With Leds: 95	4137	4205	4498
	Fabric class 3				2671	2931	3105	3400	3510	3943		4311	4365	4691
	No Fabric				2153	2244	2404	2531	2646	2935		3355	3457	3610
3,5m	Fabric class 1	4,24m					3047	3307	3416	3866	6,25m	4193	4257	4510
	Fabric class 2	With Leds: 95					3155	3440	3553	4029	With Leds: 95	4354	4410	4863
	Fabric class 3						3287	3605	3717	4226		4552	4592	5056
	No Fabric						2449	2574	2692	3066		3388	3548	3995
4,0m	Fabric class 1	4,74m						3548	3658	4150	7,00m		4643	
	Fabric class 2	With Leds: 95						3694	3801	4320	With Leds: 95		4813	
	Fabric class 3													
	No Fabric							2811	2929	3303			3854	
Type	Type A		-339	-339	-381	-407	-461	-499	-536	-608		-627	-691	-713
	Type B		-186	-186	-216	-234	-276	-315	-344	-354		-372	-409	-424
	Type H		-157	-157	-184	-195	-227	-266	-292	-297		-315	-340	-355
	Type I													
	Type K		81	91	103	116	130	140	156	166		178	195	209
	Gutter profile (in option for A,B & H)		137	137	160	165	194	233	251	251		269	269	297
Motor	Sunea io + Situo 1 io													
	Sunea CSI + Situo 1 io [ⓑ]		66	66	66	66	66	66	66	66				
	Orea WT+ switch		-131	-131	-131	-131	-131	-131	-131	-131		-135	-135	-135
	NHK + switch [ⓑ]		31	31	31	31	31	31	31	31		30	30	30
	Gear		-479	-479	-479	-479	-479	-479	-479	-479				
	Ceiling brackets projection <3m		193	193	193	193	288	288	288	479		479	479	670
Ceiling brackets projection ≥3m				288	288	479	479	479	479		670	670	670	
Laq [ⓑ] + £298 [ⓑ]		164	174	188	200	212	224	238	247		311	321	335	

[ⓐ] B35 Elite up to 7,5m: fabric delivered in 1 part [ⓑ] Additional set-up cost of £298, independently from dimensions or quantities [ⓓ] Coupled awnings without cover joint or with a fabric in 1 part (B35 Elite & B35 Prestige): min. dimensions - 320mm [ⓔ] If NHK motor or Somfy Sunea CSI io, then minimum dimension + 50mm.

Options

- 1 Operation
- 2 Sensors
- 3 Lighting
- 4 Heaters
- 5 Integrated lead rail support
- 6 Supplementary arms & brackets

Fabric in 1 part (coupled awnings)

Only for 2 arms

Gear with hand crank 1,4m instead of motor
 Hand crank 1,6m / 1,8m / 2,0m / 2,5m

 81

 81

 27

 82

 42

 25

£389

Table











£18

B35 Elite

Brackets per width/projection

Projection Width	1,5m	2,0m	2,5m	3,0m	3,5m	4,0m
2,05 - 3,00	2	2				
3,01 - 3,50	2	2	2	3		
3,51 - 4,00	2	2	2	3		
4,01 - 4,49	3	3	3	5	5	
4,50 - 5,99	3	3	3	5	5	5
6,00	5	5	5	5	5	5
6,01 - 7,00 ³	5	5	5	7	7	7
7,01 - 7,50 ³	7	7	7	7	7	
7,51 - 8,00 ⁴	4	4	4	6		
8,01 - 9,49 ⁴	6	6	6	10	10	
9,50 - 12,0 ⁴	6	6	6	10	10	10
12,01 - 15,0 ⁶	10	10	10	14	14	

³ 3 arms ⁴ 4 arms ⁶ 6 arms

	minimum width when 4 arms	8m ³	9m	10m	11m	12m	minimum width when 6 arms	12m	13m	14m	15m	
		4 arms + Sunea io + Situio 1 io						6 arms + Sunea io + Situio 1 io				
1,5m	4,50m ^D With Leds:  95	4555	4907	5280	5502	5794	7,10m With Leds:  95		6929	7178	7570	
		4690	5043	5442	5664	5984		7118	7328	7766		
		4843	5196	5401	5626	6201		7336	7509	7989		
		4042	4365	4608	4849	5017		6169	6426	6861		
2,0m	5,60m ^D With Leds:  95	4756	5108	5516	5742	6071	8,60m With Leds:  95		7221	7444	7873	
		4927	5278	5719	5942	6307		7460	7632	8115		
		5118	5470	5951	6174	6580		7731	7863	8389		
		4082	4405	4651	4888	5059		6230	6498	6936		
2,5m	6,50m ^D With Leds:  95	4959	5311	5757	5977	6788	9,90m With Leds:  95	7321	7515	7705	8161	
		5163	5513	6001	6224	7032		7602	7802	7933	8459	
		5391	5745	6277	6499	7323		7929	8127	8205	8787	
		4123	4444	4689	4930	5647		6077	6289	6555	7001	
3,0m	7,42m ^D With Leds:  95	5212	5563	6045	6270	7138	11,00m With Leds:  95	7692	7889	7983	8470	
		5452	5803	6332	6557	7422		8021	8220	8245	8818	
		5718	6069	6655	6878	7768		8405	8600	8715	9204	
		4221	4546	4787	5031	5792		6224	6437	6640	7075	
3,5m	8,60m ^D With Leds:  95		5885	6403	6610	7506	12,53m With Leds:  95		8260	8387		
			6157	6729	6880	7944			8582	9175		
			6461	7098	7210	8335			8976	9227		
			4631	4877	5212	6048			6685	7006		
4,0m	9,60m ^D With Leds:  95			6811	7030							
				7158	7378							
				5224	5459							
Type		-383	-447	-525	-580	-590		-590	-627	-639	-639	
		included						included				
		215	240	266	290	313		313	339	370	370	
		328	382	460	498	498		498	537	537	537	
Motor		included					included					
		-138	-138	-138	-138	-138	-151	-151	-151	-151		
		42	42	42	42	42	13	13	13	13		
		384	574	574	574	574	574	957	957	957		
		574	957	957	957	957	574	1340	1340	1340		
		394	419	445	468	494	593	618	642	735		

B35 Prestige

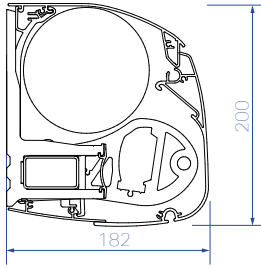

B35 Prestige (Type I)
Standard

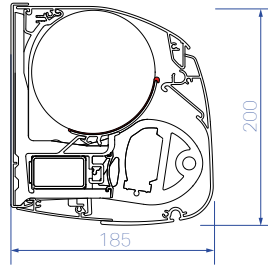

B35 Prestige (Type K)

Features

- Awning with tube system and open / semi-closed / closed box
- 6 Beaufort
- Width = 7,5 (coupled 15m) / Projection 4m
- Standard equipped with a gutter profile.
- Fabric in 1 part possible with coupled awnings.

Colours

Standard Colours



all RAL standard

Brustor Preferred List



Special finish



Projection	Width	minimum width when 2 arms	3,53m	4m	4,5m	5m	5,5m	6m	minimum width when 3 arms	6,5m	7m	7,5m	
			2 arms + Sunea io + Situo 1 io type I							3 arms + Sunea io + Situo 1 io type I			
3m	Fabric class 1	3,53m With Leds: 95	2798	3035	3231	3509	3628	4066	5,49m With Leds: 95	4482	4568	4855	
	Fabric class 2		2881	3146	3342	3643	3764	4229		4644	4721	5054	
	Fabric class 3		2979	3278	3475	3809	3932	4428		4844	4903	5277	
	No Fabric		2383	2486	2663	2805	2935	3268		3737	3857	4027	
3,5m	Fabric class 1	4,24m With Leds: 95			3407	3702	3828	4339	6,25m With Leds: 95	4709	4781	5067	
	Fabric class 2				3531	3855	3978	4530		4893	4955	5474	
	Fabric class 3				3685	4044	4169	4755		5119	5163	5694	
	No Fabric				2716	2851	2985	3417		3776	3961	4470	
4m	Fabric class 1	4,74m With Leds: 95			3603	3840	3958	4499	7,00m With Leds: 95			4987	
	Fabric class 2				3731	4000	4118	4689				5177	
	Fabric class 3												
	No Fabric				2955	3022	3152	3562				4115	
Type	Type I		included								included		
	Type K		103	116	130	140	156	166		178	195	209	
Motor	Sunea io + Situo 1 io		included								included		
	Sunea CSI + Situo 1 io		66	66	66	66	66	66					
	NHK + switch		157	157	157	157	157	157		157	157	157	
	Orea WT + switch		-131	-131	-131	-131	-131	-131		-135	-135	-135	
Ceiling brackets			288	288	479	479	479	479		670	670	670	
Lacq			included								included		

- Ⓒ No lacquer costs for B35 Prestige in Brustor Preferred List RAL colours. Ⓓ Coupled awnings without cover joint or with a fabric in 1 part (B35 Elite & B35 Prestige): min. dimensions - 320mm
 Ⓕ If NHK motor or Somfy Sunea CSI io, then minimum dimension + 50mm.

B35 Prestige

Options

- 1 Operation
- 2 Sensors
- 3 Lighting
- 4 Heaters
- 5 Integrated lead rail support
- 6 Supplementary arms & brackets

 **81**
 **81**
 **27**
 **82**
 **42**
 **25**

Brackets per width/projection

Projection Width	3,0m	3,5m	4,0m
3,53 - 4,00	3		
4,01 - 4,49	5	5	
4,50 - 5,99	5	5	5
6,00	5	5	5
6,01 - 7,00 3	7	7	7
7,01 - 8,00 4	6		
8,01 - 9,49 4	10	10	
9,50 - 12,0 4	10	10	10
12,01 - 15,0 6	14	14	





3 3 arms **4** 4 arms **6** 6 arms

Only for 2 arms

Gear with hand crank 1,4m instead of motor
 Hand crank 1,6m / 1,8m / 2,0m / 2,5m

Table

£18

	minimum width when 4 arms	8m	9m	10m	11m	12m	minimum width when 6 arms	12m	13m	14m	15m
		4 arms + Sunea io + Situio 1 io TYPE I						6 arms + Sunea io + Situio 1 io TYPE I			
3m	7,42m With Leds:  95	5865	6261	6806	7055	8055	11,10m With Leds:  95	8680	8902	9006	9567
		6141	6538	7132	7387	8381		9059	9282	9310	9968
		6445	6842	7507	7758	8780		9499	9717	9853	10410
		4721	5086	5355	5626	6500		6987	7227	7458	7959
3,5m	8,60m With Leds:  95		6630	7217	7447	8477	12,62m With Leds:  95		9326	9473	
			6944	7589	7759	8982			9695	10378	
			7293	8014	8137	9429			10153	10440	
			5184	5453	5837	6798			7512	7881	
4m	9,60m With Leds:  95			7377	7618						
				7759	7995						
				5626	5882						
Type		215	240	266	290	313		313	339	370	370
Motor		168	168	168	168	168		139	139	139	139
		-138	-138	-138	-138	-138		-151	-151	-151	-151
		575	958	958	958	958		0	1340	1340	1340
		included						included			

B38 Elite

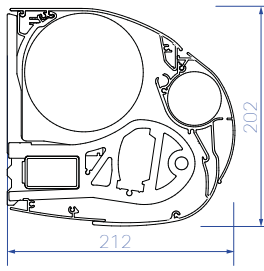

B38 Elite (Type I)
Standard

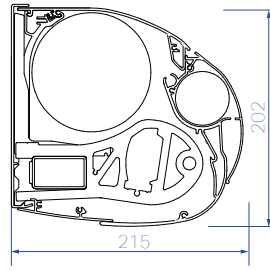

B38 Elite (Type K)

Options

- 1 Operation 81
- 2 Sensors 81
- 3 Lighting 27
- 4 Heaters 82
- 5 Supplementary arms & brackets 25

Colours

Standard Colours

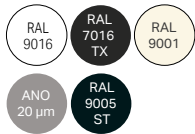

Other RAL-colours see table



Brustor Preferred List
91

Special finish **90**



Brackets per width/projection

Projection \ Width	1,5m	2,0m	2,5m	3,0m	3,5m
3,00 - 3,50	2	2	2	3	
3,51 - 4,00	2	2	2	3	
4,01 - 4,49	3	3	3	5	5
4,50 - 5,99	3	3	3	5	5
6,00	5	5	5	7	

Features

- Awning with variable valance that disappears in the lead rail.

	Width	Projection	minimum width when 2 arms	3,0m	3,5m	4,0m	4,5m	5,0m	5,5m	6,0m	minimum width when 3 arms	6,0m 3 arms + Sunea io + Situo 5 io
				2 arms + Sunea io + Situo 5 io								
1,5m	Fabric class 1	2,05m	With Leds: 95	2182	2282	2434	2610	2797	2908	3056	3,05m With Leds: 95	3189
				2225	2322	2492	2666	2865	2972	3135		3358
				2276	2373	2556	2729	2946	3058	3234		3358
				1966	2070	2159	2321	2442	2559	2646		2821
2,0m	Fabric class 1	2,57m	With Leds: 95	2256	2355	2526	2703	2906	3017	3182	3,85m With Leds: 95	3317
				2310	2405	2594	2770	2994	3102	3285		3414
				2372	2469	2679	2855	3093	3204	3406		3533
				1983	2088	2180	2340	2464	2581	2663		2851
2,5m	Fabric class 1	3,00m	With Leds: 95	2330	2423	2618	2792	3017	3128	3470	4,48m With Leds: 95	3602
				2396	2485	2700	2876	3118	3229	3590		3718
				2469	2559	2798	2976	3198	3352	3737		4068
				2006	2105	2197	2362	2483	2581	2865		3052
3,0m	Fabric class 1	3,50m	With Leds: 95		2529	2734	2910	3154	3263		5,49m With Leds: 95	3974
					2602	2833	3007	3271	3380			4108
					2686	2947	3122	3417	3525			4274
					2156	2246	2409	2534	2651			3341
3,5m	Fabric class 1	4,24m	With Leds: 95				3063	3324		Option: B38 Prestige	Option: B38 Prestige	
							3171	3456				
							3303	3622				
							2450	2575				
Motorsawning	Sunea io + Situo 5			included								included
	Sunea CSI io + Situo 5 io F			66	66	66	66	66	66	66		
	Orea WT + switch			-144	-144	-144	-144	-144	-144	-144		-151
	NHK + switch F			16	16	16	16	16	16	16		16
Type	Type I			included								included
	Type K			91	103	116	130	140	156	166		166
Valance with motor	Acryl fabric plain / Soltis W96			790	825	854	891	919	953	997		997
	Soltis 86			901	970	1002	1069	1103	1170	1211		1211
	Soltis 92 of 96			956	1033	1076	1150	1192	1268	1320		1320
	Sunea io			included								included
	LT motor + switch			-126	-126	-126	-126	-126	-126	-126		-126
Options	Ceiling brackets projection <3m			194	194	194	194	288	288	288		479
	Ceiling brackets projection ≥3m					288	288	479	479	479		479
Lacq 90 + £298 F				204	222	238	252	269	285	305		352

F Additional set-up cost of £ 298, independently from dimensions or quantities **F** If NHK motor or Somfy Sunea CSI io, then minimum dimension + 50mm.

Trade Price March 2026 exc VAT.

B38 Prestige

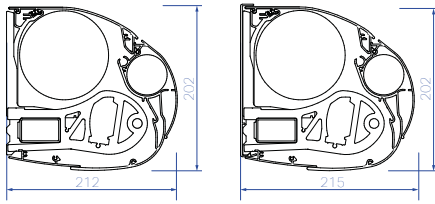
 B38 Prestige (Type I)
Standard

B38 Prestige (Type K)

Options

- 1 Operation 📖 81
- 2 Sensors 📖 81
- 3 Lighting 📖 27
- 4 Heaters 📖 82
- 5 Supplementary arms & brackets 📖 25

Colours

Standard Colours Brustor Preferred List Special finish

ANO 20 µm 📖 91 📖 90

all RAL standard

Brackets per width/projection

Width	Projection	
	3,0m	3,5m
3,53 - 4,00	3	
4,01 - 5,99	5	5
6,00	7	7

Features

- Awning with variable valance that disappears in the leadrail.
- Standard equipped with a gutter profile.

	Width	minimum width when 2 arms	3,53m	4,0m	4,5m	5,0m	5,5m	minimum width when 3 arms	6,0m
			2 arms + Sunea io + Situo 5						3 arms
3,0m	Fabric class 1	3,53m With Leds: 95	2799	3035	3230	3502	3624	5,49m With Leds: 95	4502
	Fabric class 2		2881	3145	3339	3636	3758		4679
	Fabric class 3		2979	3279	3475	3809	3932		4863
	No Fabric								
3,5m	Fabric class 1	4,24m With Leds: 95			3406	3694	3818	6,00m	4788
	Fabric class 2				3528	3846	3971		4980
	Fabric class 3				3685	4044	4157		5204
	No Fabric								
Type	Type I		included						included
	Type K		103	116	130	140	156		166
Valance with motor	Acryl fabric plain / Soltis W96	1,0m	825	854	891	919	953		997
	Soltis 86	1,3m	970	1002	1069	1103	1170		1211
	Soltis 92 of 96	1,3m	1033	1076	1150	1192	1268		1320
	Sunea io		included						included
Ceiling brackets			288	288	479	479	479		479
Lacq			included						

No lacquer costs for B38 Prestige in Brustor Preferred List RAL colours

Supplementary brackets & arms

Supplementary brackets B20

	price per piece	price per set	price per running meter
Angle fixation set		145	

Supplementary brackets B35, B38

	price per piece	price per set	price per running meter
Ceiling bracket 9 cm (in awning colour)	34		
Wall bracket 9 cm	97		

Supplementary brackets B24, B25, B27

	price per piece	price per set	price per running meter
Ceiling bracket 5 cm (in awning colour)	51		
Ceiling bracket 10 cm (in awning colour)	84		
Wall bracket 10 cm	21		
Wall bracket 30 cm	31		
Wall bracket 50 cm	42		
Special roof bracket	93		
Long end fixing bracket 50 cm (max B 5m and U 3m / B 5,5m and U 2,5m)		214	
Long end fixing bracket 70 cm (max B 5m and U 3m / B 5,5m and U 2,5m)		261	
Wall bracket per running meter			65
Sealing strip			26

△ Long end fixing bracket: max **B** 5m en **U** 3m / **B** 5,5m en **U** 2,5m

△ Long end fixing bracket not for B25 Elite / Prestige Valance

Supplementary brackets B50 S / XL

	price per piece	price per set	price per running meter
Set of 2 wall brackets 30 cm (instead of standard)		59	
Set of 2 long end brackets 50 cm in standard colour		160	
Set of 2 long end brackets 70 cm in standard colour		204	

△ Long end fixing bracket: max **B** 5m en **U** 3m / **B** 5,5m en **U** 2,5m

Supplementary 3rd arm

Type	Projection	Price	To be installed from	With Leds to be installed from
B25, B27	1,5 m	239	3,05 m	
	2 m	249	3,85 m	
	2,5 m	260	4,48 m	
	3 m	279	5,17 m	
B24 Elite, B25 Elite, B27 Elite	1,5 m	239	3,05 m	
	2 m	249	3,85 m	
	2,5 m	260	4,48 m	
	3 m	279	5,25 m	
	3,5 m	392	6,00 m	
B24 Prestige, B25 Prestige, B27 Prestige	3 m	279	5,25 m	5,44 m
B35 Elite	1,5 m	239	3,05 m	
	2 m	249	3,85 m	
	2,5 m	260	4,48 m	
	3 m	279	5,49 m	
	3,5 m	287	6,25 m	
	4 m	323	7,00 m	
B35 Prestige	3 m	386	5,49 m	5,62 m
B38 Elite	1,5 m	239	3,05 m	
	2 m	249	3,85 m	
	2,5 m	260	4,48 m	
	3 m	279	5,49 m	
B38 Prestige	3 m	386	5,49 m	5,67 m

Supplementary 4th arm

Type	Projection	Price	To be installed from
B25, B27	1,5 m	239	4,50 m
	2 m	249	5,60 m
	2,5 m	260	6,50 m
	3 m	279	7,32 m
B24 Elite, B25 Elite, B27 Elite	1,5 m	272	4,50 m
	2 m	284	5,60 m
	2,5 m	294	6,50 m
	3 m	318	7,48 m
B35 Elite	1,5 m	239	4,50 m
	2 m	249	5,60 m
	2,5 m	260	6,50 m
	3 m	279	7,42 m
B38 Elite	1,5 m	239	4,05 m
	2 m	249	5,10 m

△ B25 Standard / Elite / Prestige the cost to be deducted for 2 arms instead of 3 for a width between 5,51m and 6m (max 3,5 m projection)

Trade Price March 2026 exc VAT.

Awning Brackets - Specials

Zinc plate treatment (anti-corrosion) under painted finish to your awning colour

<p>Spreader Plate</p>		<p>£94 Each</p>
<p>Step Off bracket</p>		<p>£345 Each</p>
<p>Drainpipe Bracket</p>		<p>£153 Each</p>
<p>Ceiling Fix</p>		<p>B28/B27/B28E/B27E/B24E/ B50/B50XL See Supplementary Brackets Page 25</p>
<p>T Plate Roof Bracket for Truss Fixing</p>		<p>£165 Each</p>
<p>Special Goalpost fixing with foot or ground sleeve</p>		<p>Price on Application</p>

When ordering brackets please specify quantity and model of awning along with colour
Other designs available please ask

LED lighting

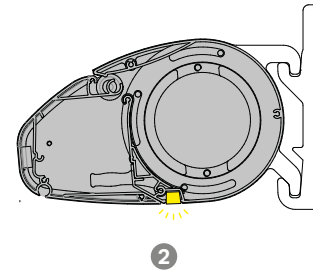
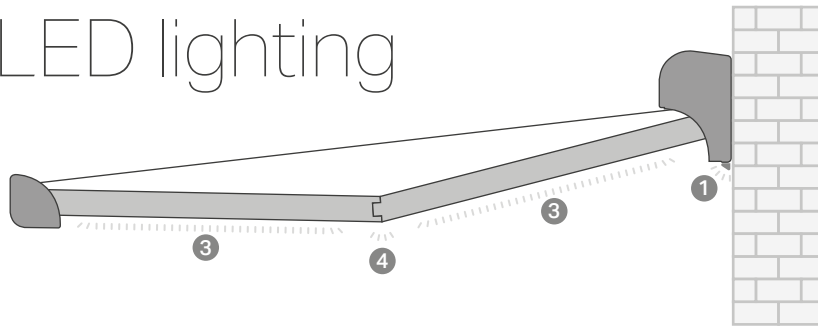

1 LED strip under box													Length Led strip							
	B24 E	B24 P	B25	B25 E	B25 P	B27	B27 E	B27 P	B35 E	B35 P	B38 E	B38 P	B50	B50 XL	B50 S	≤4m	≤5m	≤6m	≤7m	≤7,5m
under box - Brustor dimmable	☑	☑	☑	☑	☑	☑	☑	☑	☑	☑	☑	☑				585	632	731	761	806
under box - Somfy io dimmable	☑	☑	☑	☑	☑	☑	☑	☑	☑	☑	☑	☑				703	749	849	878	924
Lacquer costs  																54	67	80	93	99

2 LED strip in box													Length Led strip					
	B24 E	B24 P	B25	B25 E	B25 P	B27	B27 E	B27 P	B35 E	B35 P	B38 E	B38 P	B50	B50 XL	B50 S	≤4m	≤5m	≤6m
in box - Brustor dimmable														☑	☑	645	645	645
in box - Somfy io dimmable														☑	☑	759	759	759
in box - Somfy io dimmable - built-in receiver														☑	☑	1171	1171	1171



3 LED strip in entire arm													Number of arms						
	B24 E	B24 P	B25	B25 E	B25 P	B27	B27 E	B27 P	B35 E	B35 P	B38 E	B38 P	B50	B50 XL	B50 S	2 arms	3 arms	4 arms	6 arms
in entire arm - Brustor dimmable	☑	☑		☑	☑		☑	☑	☑	☑	☑	☑		☑		702	948	1367	2008
in entire arm - Somfy io dimmable	☑	☑		☑	☑		☑	☑	☑	☑	☑	☑		☑		821	1129	1486	2126
in entire arm - Somfy io dimmable - built-in receiver														☑		1233	0	0	0

4 LED spot in elbow													Number of arms						
	B24 E	B24 P	B25	B25 E	B25 P	B27	B27 E	B27 P	B35 E	B35 P	B38 E	B38 P	B50	B50 XL	B50 S	2 arms	3 arms	4 arms	6 arms
in elbow Somfy io not dimmable		☑			☑			☑		☑		☑				643	903	1231	1748

Reduction in case of a combination of LED strips in the arm and the box on one control (Somfy io dimmable 4-channel / max 12 m).

- £299

LED lighting Per type awning	1 under box	2 in box	3 entire arm	4 in elbow	Possible combination of LED systems
B25 / B27	☑				1
B24 / B25 / B27 Elite	☑		☑		1 / 3
B24 / B25 / B27 Prestige	☑		☑	☑	1 / 3 or 1 / 4
B35 Elite	☑		☑		1 / 3
B35 Prestige	☑		☑	☑	1 / 3 or 1 / 4
B38 Elite	☑		☑		1 / 3
B38 Prestige	☑		☑	☑	1 / 3 or 1 / 4
B50					
B50 S		☑			2
B50 XL		☑	☑		2 / 3

 The integration of the RTS transmitter has an effect on the maximum projection of the awning see page 75  No lacquer costs for LED strips in the 5 standard colours: RAL 9016, RAL 7016 antracite textured, RAL 9001 cream, Anodised 20µm, RAL 9005 jet black texture
Trade Price March 2026 exc VAT.

LED lighting	Suitable for	Number of leds & consumption	Colour temperature	Lighting ^A	Remote control
1 LED strip under box 	B24 Elite / Prestige B25 / B25 Elite / Prestige B27 / B27 Elite / Prestige B35 Elite / Prestige B38 Elite / Prestige	96 LEDs (+/- 7,5 Watt) per meter	Warm white 3250°K - 3500°K Option: 2700°K (+£56)	up to 575 lumen per meter	<ul style="list-style-type: none"> • Brustor dimmable • Somfy io dimmable
2 LED in box 	B 50 S / B50 XL	96 LEDs (+/- 7,5 Watt) per meter	Warm white 3250°K - 3500°K	up to 350 lumen per meter	<ul style="list-style-type: none"> • Brustor dimmable • Somfy io dimmable • Somfy io dimmable with built-in receiver
3 LED strip in entire arm 	B24 Elite / Prestige B25 Elite / Prestige B27 Elite / Prestige B35 Elite / Prestige B38 Elite / Prestige B50 XL	60 LEDs (+/- 5 Watt) per meter	Warm white 3250°K - 3500°K	up to 200 lumen per meter per arm	<ul style="list-style-type: none"> • Brustor dimmable • Somfy io dimmable • Somfy io dimmable with built-in receiver (only for B50 XL)
4 LED spot in elbow 	B24 Prestige B25 Prestige B27 Prestige B35 Prestige B38 Prestige	1 powerLED (+/- 3 Watt) per awning	Natural white 4.250 - 4.750° K	up to 170 lumen per arm	Somfy io

^A Reference: classic 25 Watt lamp = 200 lumen

1 LED strip under box

- Led system fixation under the box or on the wall.
- Length Led strip: total length of the box up to max 7,5m.
- Coupled awnings: 2 Led strips up to max 2 x 7,5m.
- Dimensions: 28mm high x 41mm deep x up to 7500mm long.
- Waterproof and dustproof (IP67), perfect to use outside.
- Dimmable io receiver (30cm width) can be built in in the housing. ^B
- 24 Volt Led strip with 96 Leds per meter.
- Light output & consumption: 575 lumen & 7,5 Watt per meter.
- Colour temperature: 3.250° - 3.500° Kelvin (warm white).
- 2.700°K in option (£56 surcharge).
- Anti-glare plexi cap for a more diffused light.
- Available in 2 versions:
 - Fixation during the fabrication or during the installation.
 - Need to be fixated on the wall / under an awning.

3 LED strip in entire arm

- Lighting system fixation under the arm.
- Waterproof and dustproof (IP67), perfect to use outside.
- Dimmable io receiver (30cm width) can be built in in the housing ^B
- Remote control with io Somfy transmitter, available in option.
- 24 Volt Led strip with 60 Leds per meter.
- Light output & consumption: 5 Watt per meter.
- Colour temperature: 3.250° - 3.500° Kelvin (warm white).
- Price depends on the number of arms, not on the projection.

2 LED strip in box

- Led system fixation in the box
- 24 Volt Led strip with 96 Leds per meter.
- Light output & consumption: 575 lumen & 7,5 Watt per meter.
- Colour temperature: 3.250° - 3.500° Kelvin (warm white).
- Anti-glare plexi cap for a more diffused light.

4 LED spot in elbow

- LED strip in the elbow of the arms (not dimmable).
- Waterproof and dustproof (IP67), perfect to use outside.
- Not dimmable io receiver (25cm width) can be built in in the housing. ^B
- 1 x 12 Volt PowerLed with 170 lumen output per elbow.
- Colour temperature: 4.250° - 4.750° Kelvin (natural white).

Brustor LED operation



- 1 Brustor dimmable white leds



Extra options awnings

Valance

	N° of stripes Width	1	2	3	4	5	6	7	Surcharge > 8,170m £ / m
		1,095	2,295	3,470	4,645	5,820	6,995	8,170	
Projection		Valance with standard height of 21 cm							
valance straight	Fabric class 1	41	50	56	75	82	99	126	18
	Fabric class 2 - 3	55	62	71	96	103	129	164	25
valance waved	Fabric class 1	52	60	71	93	103	124	157	24
	Fabric class 2 - 3	65	77	84	115	124	155	195	30
price per 5cm extra	Fabric class 1	9	11	12	13	14	16	16	3
	Fabric class 2 - 3	9	12	14	16	17	19	19	4

Lead rail support for awnings

- Can be fixated at the front profile of the awnings B25, B25 Elite, B25 Prestige, B27, B27 Elite, B35 Elite, B35 Prestige.
 ⚠ **Not possible for B24 Elite / Prestige!**
- Consists of 2 telescopic legs stored in a box underneath the lead rail (height of the box: 30mm)

Width	4m	4,5m	5m	5,5m	6m	6,5m	7m
Price	609	620	626	636	643	655	668

Side panels

- For awnings B25 Prestige, B25 Elite, B25, B27 Prestige, B27 Elite, B27, B35 Elite, B35 Prestige, B38 Prestige and B38 Elite
- Consists of side panel and rafter for side panel
- Rafter for side panel also available separately

Projection (m)	1,5	2	2,5	3	3,5	3,75	4
Side panels + rafter	267	267	331	331	359	432	432
Rafter without side panel	79	79	99	99	99	124	124

Colours sidepanels

Standard Colours



Other RAL-Colours



surcharge: **£15/ metre**
 if ordered simultaneously with
 awning
 Brustor Preferred List
 91

Conservatory awning application limits

Scale 1/100
In metres
width horizontal
projection vertical

Width →
Projection ↓
Topscreen: max dimensions and application limits

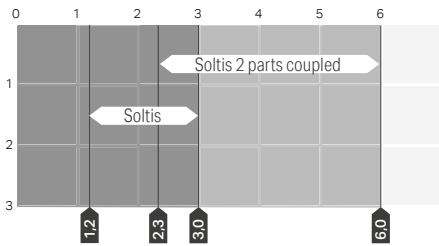

B126 Conservatory awning: max dimensions and application limits

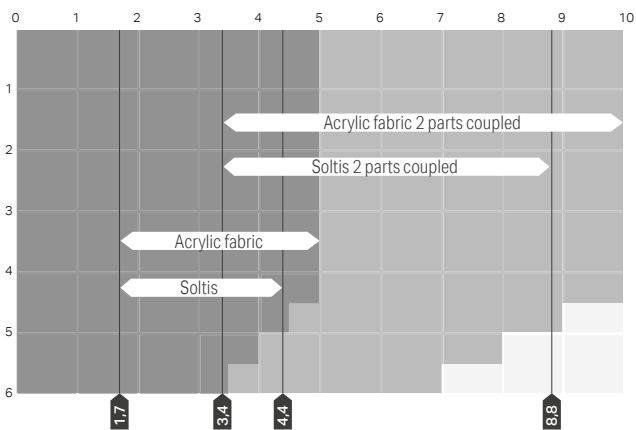

B128 Veranda: max dimensions and application limits

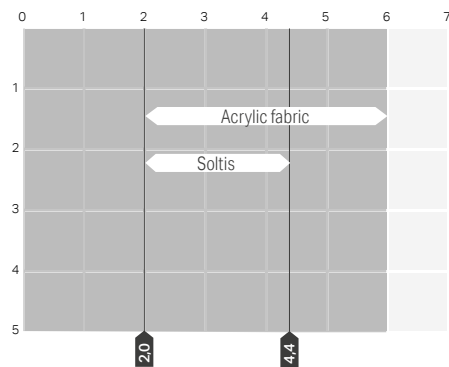

B127 Veranda: max dimensions and application limits

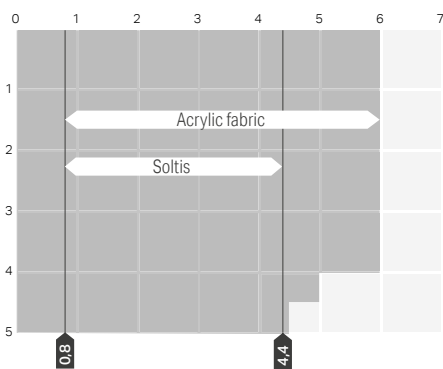

B129: max dimensions and application limits

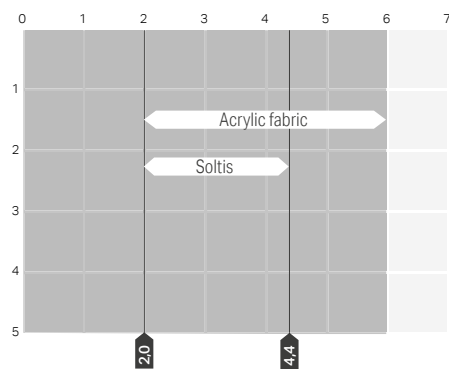

Topscreen

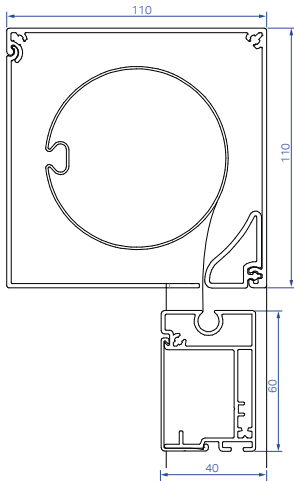

Box

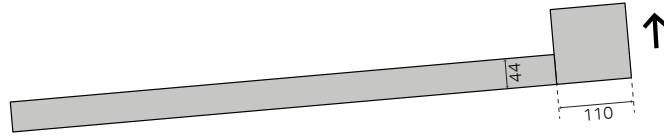

Always mount with box facing upwards

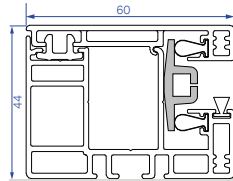

Side rail

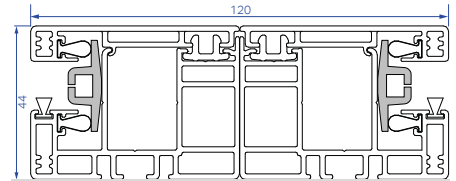

Couple rail

Colours

Standard Colours

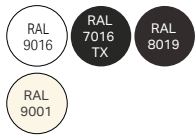

Other RAL-Colors



Set-up cost:
£200 (<3 screens),
£100 (<5 screens),
free (≥5 screens)

Brustor Preferred List
91

Special finish

90

Options

Sergé 600 Blockout LUNAR/SOLAR surcharge instead of Soltis 86

£41/m²



Sensors

81



Orea WT + switch

Table

		Width									extra spacing profile
		1,25m - 1,30m	1,31m - 1,50m	1,51m - 1,70m	1,71m - 1,90m	1,91m - 2,10m	2,11m - 2,30m	2,31m - 2,50m	2,51m - 3,00m		
Height		TOPSCREEN including Sunea io + Situo 1 io									
1,30 - 0,80	Soltis 86	1239	1269	1297	1328	1357	1384	1413	1707	27	
	Soltis 92	1309	1342	1375	1411	1440	1472	1507	1749	27	
	Lacq + £298	39	41	46	49	52	56	60	63	27	
1,50 - 1,31	Soltis 86	1266	1297	1328	1358	1390	1418	1448	1763	31	
	Soltis 92	1339	1375	1411	1446	1480	1512	1547	1812	31	
	Lacq + £298	39	44	48	51	54	57	61	66	31	
1,70 - 1,51	Soltis 86	1293	1326	1358	1390	1418	1454	1484	1834	34	
	Soltis 92	1368	1405	1442	1480	1514	1552	1589	1888	34	
	Lacq + £298	41	46	49	52	56	60	63	67	34	
1,90 - 1,71	Soltis 86	1320	1354	1386	1418	1454	1486	1520	1920	41	
	Soltis 92	1397	1437	1476	1514	1556	1594	1633	1979	41	
	Lacq + £298	44	48	51	54	57	61	66	69	41	
2,10 - 1,91	Soltis 86	1347	1380	1416	1449	1485	1520	1556	1985	46	
	Soltis 92	1428	1469	1509	1550	1594	1633	1674	2048	46	
	Lacq + £298	46	49	52	56	60	63	67	71	46	
2,30 - 2,11	Soltis 86	1374	1411	1446	1482	1519	1552	1589	2041	50	
	Soltis 92	1461	1502	1544	1585	1630	1673	1714	2111	50	
	Lacq + £298	48	51	54	57	61	66	69	72	50	
2,50 - 2,31	Soltis 86	1401	1438	1475	1514	1549	1588	1626	2102	53	
	Soltis 92	1491	1536	1579	1625	1670	1712	1756	2174	53	
	Lacq + £298	49	52	56	60	63	67	71	76	53	
3,00 - 2,51	Soltis 86	1862	1907	1952	1997	2043	2088	2135	2141	56	
	Soltis 92	1900	1952	2003	2054	2107	2157	2210	2337	56	
	Lacq + £298	51	54	57	60	66	69	72	76	56	

6 sets of spacing profiles included in price

Motor	Sunea io + Situo 1 io	included								
	Orea WT + switch	-87	-87	-87	-87	-87	-87	-87	-87	-87

© < 3 screens: Additional set-up cost of **£298** / < 5 screens: Additional set-up cost of **£60** / ≥5: **no Set-up cost**.
 Trade Price March 2026 exc VAT.

Topscreen coupled

- Windproof and motorised screen for horizontal glazing and small conservatories.
- Combination of Zip-screen technology and screens with spring systems
- Rectangular box of 11cm by 11cm
- Inclination angle between 0° (horizontal) and 90° (vertical).
- Width min 1,25m - max 3m. / Projection min. 0,8 - max 3m

- From > 2,5m standard delivered with 6 spacing profiles per (= elevation of 6cm)
- With roller tube 78mm diameter standard with "anti-wrinkle" profile ito prevent visible markings on the screen fabric.
- Coupled: if 1 part > 2,5m, spacing profiles are provided

		Width	2,50m - 3,00m	3,01m - 3,50m	3,51m - 4,00m	4,01m - 4,50m	4,51m - 5,00m	5,01m - 5,50m	5,51m - 6,00m	extra spacing profile
			TOPSCREEN Coupled							
1,30 - 0,80	Soltis 86		2240	2297	2360	2415	2471	3098	3116	53
	Soltis 92		2386	2453	2522	2583	2648	3183	3199	53
	Lacq ☉ + £298 🚚		82	89	96	102	113	119	125	53
1,50 - 1,31	Soltis 86		2297	2360	2419	2482	2538	3215	3229	61
	Soltis 92		2453	2522	2594	2661	2728	3311	3326	61
	Lacq ☉ + £298 🚚		83	93	99	107	114	123	130	61
1,70 - 1,51	Soltis 86		2355	2419	2482	2540	2609	3355	3372	68
	Soltis 92		2515	2588	2661	2732	2805	3463	3479	68
	Lacq ☉ + £298 🚚		89	96	102	113	119	125	132	68
1,90 - 1,71	Soltis 86		2411	2475	2540	2609	2675	3526	3542	81
	Soltis 92		2577	2655	2732	2811	2891	3646	3661	81
	Lacq ☉ + £298 🚚		93	99	107	114	123	130	136	81
2,10 - 1,91	Soltis 86		2462	2532	2601	2673	2742	3656	3672	89
	Soltis 92		2641	2723	2804	2891	2968	3784	3800	89
	Lacq ☉ + £298 🚚		96	102	113	119	125	132	141	89
2,30 - 2,11	Soltis 86		2522	2594	2665	2739	2808	3768	3784	98
	Soltis 92		2707	2789	2874	2961	3049	3908	3924	98
	Lacq ☉ + £298 🚚		99	107	114	123	130	136	143	98
2,50 - 2,31	Soltis 86		2579	2653	2730	2801	2877	3890	3905	103
	Soltis 92		2774	2861	2950	3042	3125	4034	4050	103
	Lacq ☉ + £298 🚚		102	113	119	125	132	141	149	103
3,00 - 2,51	Soltis 86		3518	3605	3698	3789	3880	4972	4986	112
	Soltis 92		3605	3708	3812	3915	4018	5121	5136	112
	Lacq ☉ + £298 🚚		107	114	120	130	136	143	151	112
12 sets of spacing profiles included in price										
Motor	Sunea io + Situo 1 io		included							
	Orea WT + switch		-87	-87	-87	-87	-87	-87	-87	-87

☉ < 3 screens: Additional set-up cost of £298 / < 5 screens: Additional set-up cost of £60 / ≥5: no Set-up cost. Trade Price March 2026 exc VAT.

Trade Price March 2026 exc VAT.

Topscreen Solar

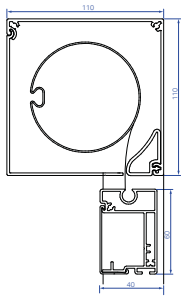

Box

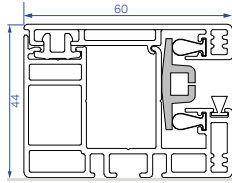

Side rail

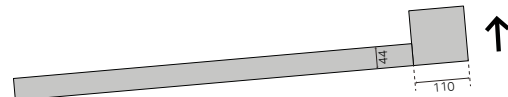

Always mount with box facing upwards

Options

Sergé 600 Blockout LUNAR/SOLAR surcharge instead of Soltis 86

£41 / m²



Sensors

81

Patio heater 2000W / 2200W

82

Colours

Standard Colours

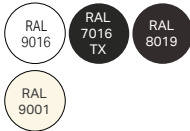

Other RAL-Colours



Set-up cost:
£200 (<3 screens),
£100 (<5 screens),
free (≥5 screens)

Brustor Preferred List
91

Special finish 90

90

- Only available with Dooya motor with integrated battery + 15-channels transmitter (**Somfy Solar not possible!**)
- Windproof and motorized screen for sloping and horizontal glazing, skylights, and small conservatories
- Combination of Zip-screen technology and screens with spring systems
- Rectangular box of 11cm by 11cm

- Inclination angle between 0° (horizontal) and 90° (vertical).
- Width min 1,25m - max 3m. / Projection min. 0,8 - max 3m
- From > 2,5m standard delivered with 6 spacing profiles per (= elevation of 6cm)
- With roller tube 78mm diameter standard with "anti-wrinkle" profile ito prevent visible markings on the screen fabric.

		Width								extra spacing profile
		1,25m - 1,30m	1,31m - 1,50m	1,51m - 1,70m	1,71m - 1,90m	1,91m - 2,10m	2,11m - 2,30m	2,31m - 2,50m	2,51m - 3,00m	
Height		TOPSCREEN including Dooya motor + 15-channels transmitter								
0,80 - 1,30	Soltis 86	1433	1463	1493	1523	1551	1580	1608	1903	27
	Soltis 92	1503	1537	1570	1605	1635	1668	1704	1945	27
	Lacq + £298	38	41	46	49	52	56	60	63	27
1,31 - 1,51	Soltis 86	1460	1493	1523	1552	1585	1612	1644	1960	32
	Soltis 92	1533	1570	1605	1641	1675	1709	1743	2009	32
	Lacq + £298	39	44	48	51	55	57	62	66	32
1,51 - 1,71	Soltis 86	1488	1521	1552	1585	1613	1649	1679	2031	34
	Soltis 92	1564	1602	1638	1675	1710	1748	1784	2086	34
	Lacq + £298	41	46	49	52	56	60	63	67	34
1,71 - 1,91	Soltis 86	1515	1548	1581	1613	1649	1682	1715	2117	41
	Soltis 92	1593	1633	1672	1710	1751	1790	1829	2176	41
	Lacq + £298	44	48	51	55	57	62	66	70	41
1,91 - 2,11	Soltis 86	1541	1574	1610	1645	1680	1715	1751	2181	46
	Soltis 92	1624	1664	1706	1747	1790	1829	1871	2246	46
	Lacq + £298	46	49	52	56	60	63	67	71	46
2,11 - 2,31	Soltis 86	1568	1605	1641	1677	1714	1749	1785	2238	50
	Soltis 92	1656	1697	1740	1781	1825	1869	1910	2309	50
	Lacq + £298	48	51	55	57	62	66	70	72	50
2,31 - 2,51	Soltis 86	1596	1633	1671	1710	1746	1783	1821	2300	53
	Soltis 92	1687	1731	1774	1820	1865	1908	1952	2372	53
	Lacq + £298	49	52	56	60	63	67	71	75	53
2,51 - 3,00	Soltis 86	2058	2105	2149	2195	2241	2286	2334	2340	56
	Soltis 92	2097	2149	2200	2252	2304	2356	2408	2535	56
	Lacq + £298	51	55	57	61	66	70	72	77	56

6 sets of spacing profiles included in price

Motor	Dooya motor + 15-channels transmitter	included
-------	---------------------------------------	----------

< 3 screens: Additional set-up cost of £298 / < 5 screens: Additional set-up cost of £60 / ≥ 5: no Set-up cost.

Trade Price March 2026 exc VAT.

B126 Conservatory awning



B126 without extension

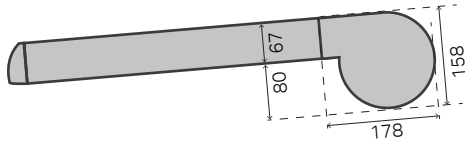

B126 with extension

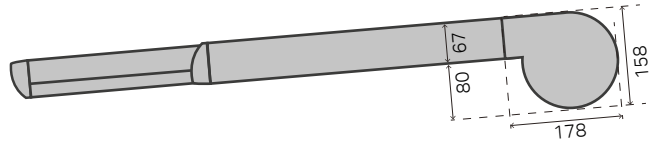

Colours

Standard Colours



Other RAL-colours see table



Brustor Preferred List

Special finish

90

What is possible?

Please take a maximum fabric surface of 19m² per single part into account. This means that the total surface, extension included, may not exceed 19m². Please see the matrix below for further information.

In order to calculate the total projection, take fixed projection + extension (e.g. 3,75m projection + 1,25m extension = 5m total projection).

Min - max dimensions per part

Fabric	Min-Max Projection	Min-Max width	Max surface
Acrylic fabric A	0,5m - 6,0m	1,7m B - 5,0m	19m ²
Soltis 86 D	0,5m - 6,0m	1,7m B - 4,4m	19m ²
Soltis 92 D	0,5m - 6,0m	1,7m B - 4,4m	18m ²

A Acrylic fabric: some small holes are provided for optimal water drainage
B Max 3m projection when 1,7m width. **D** Fold formation possible with Soltis.

*Maximum extension per projection

Fixed Projection (m)	< 1,25	min 1,25	min 1,75	min 2,25	min 2,50
Max extension (m)		0,50	0,75	1,00	1,25

Example price calculation B126 io + extension (not coupled)

- Fabric class 1 / 3,5m width / 3,75m fixed projection + 1,25m extension
- Total surface: (3,75+1,25) x 3,5 = 17,5m²
- Price: £2817 (3,5m x 5,0m) + £ 350 (1,25m extension) = £3167

Width	Projection (m) (fixed + extension)	B126 + Sunea io + Situio 1 io							Optional extension *			
		1,70m - 2,00m	2,01m - 2,50m	2,51m - 3,00m	3,01m - 3,50m	3,51m - 4,00m	4,01m - 4,50m	4,51m - 5,00m	0,5m	0,75m	1,0m	1,25m
1,50 - 0,50	Fabric class 1	1937	2063	2129	2189	2339	2401	2531				
	Fabric class 2	1962	2096	2162	2226	2385	2447	2589				
	Fabric class 3	2107	2254	2319	2380	2559	2618	2770				
	No Fabric	1651	1725	1793	1852	1931	1992	2074				
	Lacc C + £298	80	93	104	120	132	146	161				
2,00 - 1,51	Fabric class 1	2024	2163	2232	2293	2459	2520	2670	*			
	Fabric class 2	2053	2209	2276	2337	2520	2582	2743	*			
	Fabric class 3	2207	2378	2443	2505	2704	2767	2946	*			
	No Fabric	1703	1778	1844	1903	1986	2044	2125	*			
	Lacc C + £298	83	98	113	125	137	152	165				
2,50 - 2,01	Fabric class 1	2093	2253	2318	2379	2564	2624	2789	✓	*		
	Fabric class 2	2131	2303	2371	2432	2636	2697	2877	✓	*		
	Fabric class 3	2288	2484	2550	2612	2838	2897	3099	✓	*		
	No Fabric	1737	1814	1879	1938	2019	2077	2158	✓	*		
	Lacc C + £298	93	104	120	132	146	161	173				
3,00 - 2,51	Fabric class 1	2178	2356	2423	2483	2683	2744	2928	✓	✓	*	
	Fabric class 2	2224	2418	2486	2547	2769	2828	3033	✓	✓	*	
	Fabric class 3	2388	2609	2676	2736	2984	3045	3271	✓	✓	*	
	No Fabric	1790	1865	1929	1991	2072	2130	2212	✓	✓	*	
	Lacc C + £298	98	113	125	137	152	165	178				
3,50 - 3,01	Fabric class 1	2249	2441	2506	2569	2786	2856	3048	✓	✓	*	
	Fabric class 2	2298	2515	2582	2641	2886	2954	3167	✓	✓	*	
	Fabric class 3	2472	2716	2782	2843	3116	3186	3427	✓	✓	*	
	No Fabric	1823	1900	1965	2025	2106	2175	2246	✓	✓	*	
	Lacc C + £298	104	120	132	146	161	173	187				
4,00 - 3,51	Fabric class 1	2315	2527	2592	2657	2890	2950	3167	✓	✓	✓	*
	Fabric class 2	2372	2610	2676	2738	3000	3061	3306	✓	✓	✓	*
	Fabric class 3	2554	2822	2890	2950	3245	3309	3582	✓	✓	✓	*
	No Fabric	1860	1934	1998	2061	2140	2201	2280	✓	✓	✓	*
	Lacc C + £298	113	125	137	152	165	178	194				
4,50 - 4,01	Fabric class 1	2405	2635	2699	2762	3014	3074	3309	✓	✓	✓	✓
	Fabric class 2	2469	2725	2790	2853	3136	3197	3463	✓	✓	✓	✓
	Fabric class 3	2660	2950	3016	3078	3398	3460	3758	✓	✓	✓	✓
	No Fabric	1916	1989	2053	2116	2192	2255	2333	✓	✓	✓	✓
	Lacc C + £298	120	132	146	161	173	187	201				
5,00 - 4,51	Fabric class 1	2444	2690	2755	2818	3087	3148		✓	✓	✓	✓
	Fabric class 2	2515	2790	2858	2923	3222	3284		✓	✓	✓	✓
	Fabric class 3	2712	3027	3094	3154	3501	3561		✓	✓	✓	✓
	No Fabric	1919	1992	2058	2120	2201	2259		✓	✓	✓	✓
	Lacc C + £298	125	137	152	165	178	194					
5,50 - 5,01	Fabric class 1		2931	3015	3092	3395			✓	✓	✓	✓
	Fabric class 2		Min	3042	3126	3203	3543		✓	✓	✓	✓
	Fabric class 3		width	3290	3375	3450	3836		✓	✓	✓	✓
	No Fabric		2,10m	2180	2259	2335	2436		✓	✓	✓	✓
	Lacc C + £298			146	161	173	187					
6,00 - 5,51	Fabric class 1		2984	3073	3150				✓	✓	✓	✓
	Fabric class 2		Min	3110	3191	3270			✓	✓	✓	✓
	Fabric class 3		width	3368	3450	3530			✓	✓	✓	✓
	No Fabric		2,10m	2189	2266	2346			✓	✓	✓	✓
	Lacc C + £298			151	165	178						





















Without warranty

Motor	Sunea io + Situio 1 io	included						Optional extension			
	Orea WT + switch	-135	-135	-135	-135	-135	-135	312	312	312	351

C Additional set-up cost of £298

B126 Conservatory awning coupled 1 motor

- Motorised conservatory
- Telescopic extendable extension possible.
- Up to 38m² shadow surface.
- 4 standard colours, others in option.

Projection(m) (fixed+ extension)	Width	B126 coupled							Optional extension			
		3,40m - 4,00m	4,01m - 5,00m	5,01m - 6,00m	6,01m - 7,00m	7,01m - 8,00m	8,01m - 9,00m	9,01m - 10,00m	0,5m	0,75m	1,0m	1,25m
1,50 - 0,50	Fabric class 1	3416	3621	3754	3875	4160	4279	4562				
	Fabric class 2	3465	3692	3825	3946	4250	4370	4675				
	Fabric class 3	3748	4004	4134	4259	4589	4708	5042				
	No Fabric	3127	3224	3368	3503	3681	3815	3993				
	Lacq  + £298 	151	177	204	233	260	285	312				
2,00 - 1,51	Fabric class 1	3590	3829	3956	4084	4400	4520	4837	*			
	Fabric class 2	3650	3919	4046	4171	4518	4639	4983	*			
	Fabric class 3	3950	4251	4380	4506	4883	5005	5386	*			
	No Fabric	3244	3338	3478	3619	3796	3930	4107	*			
	Lacq  + £298 	163	191	216	243	270	299	324				
2,50 - 2,01	Fabric class 1	3727	4002	4123	4258	4606	4725	5079	✓	*		
	Fabric class 2	3800	4108	4231	4361	4749	4867	5255	✓	*		
	Fabric class 3	4118	4465	4587	4721	5147	5268	5696	✓	*		
	No Fabric	3318	3414	3549	3694	3873	4006	4184	✓	*		
	Lacq  + £298 	176	203	231	259	284	312	339				
3,00 - 2,51	Fabric class 1	3901	4208	4342	4463	4845	4967	5352	✓	✓	*	
	Fabric class 2	3984	4335	4470	4589	5015	5134	5563	✓	✓	*	
	Fabric class 3	4317	4715	4848	4970	5446	5565	6039	✓	✓	*	
	No Fabric	3436	3530	3678	3811	3987	4122	4298	✓	✓	*	
	Lacq  + £298 	188	215	242	269	297	322	352				
3,50 - 3,01	Fabric class 1	4041	4381	4512	4636	5053	5172	5594	✓	✓	*	
	Fabric class 2	4136	4525	4657	4780	5246	5366	5834	✓	✓	*	
	Fabric class 3	4482	4930	5059	5183	5706	5829	6351	✓	✓	*	
	No Fabric	3512	3605	3749	3885	4064	4197	4375	✓	✓	*	
	Lacq  + £298 	202	231	258	283	311	336	365				
4,00 - 3,51	Fabric class 1	4178	4552	4695	4807	5259	5383	5833	✓	✓	✓	*
	Fabric class 2	4288	4719	4859	4971	5477	5601	6107	✓	✓	✓	*
	Fabric class 3	4650	5142	5287	5397	5968	6089	6663	✓	✓	✓	*
	No Fabric	3590	3683	3838	3961	4140	4273	4452	✓	✓	✓	*
	Lacq  + £298 	214	241	268	296	321	348	378				
4,50 - 4,01	Fabric class 1	4357	4766	4899	5018	5508	5628	6116	✓	✓	✓	✓
	Fabric class 2	4480	4951	5081	5204	5750	5873	6421	✓	✓	✓	✓
	Fabric class 3	4857	5397	5531	5653	6272	6394	7011	✓	✓	✓	✓
	No Fabric	3711	3806	3951	4085	4262	4394	4573	✓	✓	✓	✓
	Lacq  + £298 	228	255	282	310	336	361	390				
5,00 - 4,51	Fabric class 1	4434	4879	5011	5134	5654	5773		✓	✓	✓	✓
	Fabric class 2	4570	5081	5215	5336	5922	6044		✓	✓	✓	✓
	Fabric class 3	4962	5552	5684	5808	6474	6596		✓	✓	✓	✓
	No Fabric	3722	3815	3958	4095	4273	4407		✓	✓	✓	✓
	Lacq  + £298 	240	268	294	320	348	374					
5,50 - 5,01	Fabric class 1		5275	5423	5563	6135			✓	✓	✓	✓
	Fabric class 2		Min width 4,20m	5497	5647	5782	6429		✓	✓	✓	✓
	Fabric class 3		5991	6140	6279	7009		✓	✓	✓	✓	
	No Fabric		4136	4300	4455	4650		✓	✓	✓	✓	
	Lacq  + £298 		281	308	335	361						
6,00 - 5,51	Fabric class 1		5386	5532	5672				✓	✓	✓	✓
	Fabric class 2		Min width 4,20m	5624	5772	5914			✓	✓	✓	✓
	Fabric class 3		6142	6290	6430				✓	✓	✓	✓
	No Fabric		4145	4310	4460				✓	✓	✓	✓
	Lacq  + £298 		292	319	346							

Without warranty

Motor	Sunea io + Situo 1 io	included						Optional extension			
	Orea WT + switch	-130	-130	-130	-130	-130	-130	624	624	624	702

 Additional set-up cost of £298

Trade Price March 2026 exc VAT.

Options

Fixed fabric support profile (per piece) **£207**



Sensors **81**
Patio heater 2000W / 2200W **82**



Orea WT + switch **Table**

⚠ Sun and wind/sun sensor is not recommended.

N° brackets per projection

Projection (m)	0,00 - 1,50	1,51 - 2,50	2,51 - 4,00	4,01 - 6,00
N° brackets	2	3	4	5

Surcharge brackets

Bracket	Adjustable	Ordered initially
D (adjustable)	106 - 165 mm	£44 / piece
E (telescopic)	up to 500 mm	£55 / piece

B127 Conservatory awning



- Standard with Sunea io + Situio 1 io.
- Acrylic fabric: max surface 22m² / max width 6m / max projection 5m
- Soltis 86: max surface 19m² / max width 4,4m / max projection 5m
- Soltis 92: max surface 18m² / max width 4,4m / max projection 5m
- Rails can be fixated up to 1m to the inside (with extension: 0,5m)
- If the side guides are installed 1m from the outside then the max width is 5m.

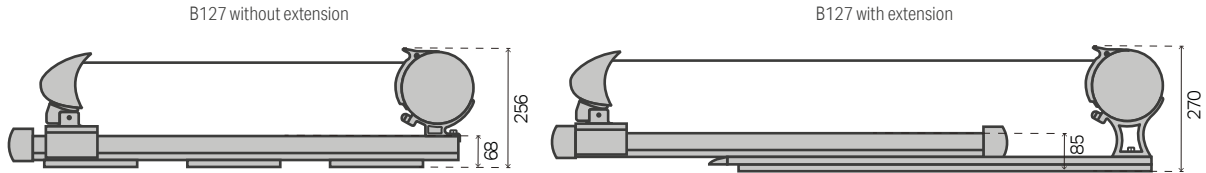

Colours

Standard Colours



Other RAL-colours see table



Brustor Preferred List 91

Special finish 90



Options



Orea WT + switch

Table

△ Sun and wind sensors are not recommended.

N° brackets per projection

Projection	< 3m	3m - 5m	with extension
Max extension	3	5	over entire length

*Maximum extension per projection

Fixed project.(m)	< 1,25	min 1,25	min 1,75	min 2,25	min 2,50
Extension max. (m)		0,50	0,75	1,00	1,25

Prices are calculated based on the total projection: the sum of the standard projection plus the length of the extension.
Example: fabric class 1 / 4m width / 3,75m fixed projection / 1,25m extension → £ 3818 (5m total projection) + £ 524 (extension) = £ 4342

Width	Projection(m) (fixed+ extension)	B127 Conservatory awning + Sunea io + Situio 1 io									Optional extension*				
		1,70m - 2,00m	2,01m - 2,50m	2,51m - 3,00m	3,01m - 3,50m	3,51m - 4,00m	4,01m - 4,50m	4,51m - 5,00m	5,01m - 5,50m	5,51m - 6,00m	0,5m	0,75m	1,0m	1,25m	Price
1,50 - 0,50	Fabric class 1	2287	2421	2515	2645	2738	2817	2949	3041	3175					
	Fabric class 2	2330	2481	2573	2726	2819	2896	3050	3142	3294					
	Fabric class 3	2360	2530	2622	2790	2883	2960	3129	3222	3391					
	No Fabric	2153	2238	2336	2420	2516	2599	2681	2778	2860					
	Laccq + £298	89	101	116	129	141	157	170	184	198					
2,00 - 1,51	Fabric class 1	2463	2612	2703	2854	2946	3023	3171	3265	3414					
	Fabric class 2	2515	2690	2782	2956	3050	3126	3303	3393	3568					
	Fabric class 3	2555	2753	2845	3041	3133	3210	3406	3497	3694					
	No Fabric	2304	2388	2486	2570	2665	2747	2833	2930	3012					
	Laccq + £298	98	113	125	137	152	165	178	194	206					
2,50 - 2,01	Fabric class 1	2555	2753	2845	3041	3133	3210	3406	3497	3694	*				320
	Fabric class 2	2609	2806	2898	3095	3187	3265	3463	3555	3753	*				320
	Fabric class 3	2661	2882	2974	3198	3290	3368	3591	3683	3905	*				320
	No Fabric	2358	2441	2539	2623	2722	2803	2887	2984	3071	*				320
	Laccq + £298	107	123	135	151	163	176	191	203	216					
3,00 - 2,51	Fabric class 1	2627	2809	2902	3083	3177	3255	3435	3527	3709	✓	*			360
	Fabric class 2	2703	2924	3015	3234	3329	3406	3623	3717	3936	✓	*			360
	Fabric class 3	2764	3014	3106	3356	3449	3524	3776	3868	4118	✓	*			360
	No Fabric	2411	2496	2593	2679	2775	2858	2944	3040	3123	✓	*			360
	Laccq + £298	120	131	144	160	172	186	200	212	226					
3,50 - 3,01	Fabric class 1	2801	3000	3092	3290	3383	3459	3657	3749	3950	✓	✓			407
	Fabric class 2	2890	3129	3222	3464	3556	3632	3875	3968	4209	✓	✓			407
	Fabric class 3	2958	3236	3330	3604	3695	3775	4051	4143	4421	✓	✓			407
	No Fabric	2565	2648	2744	2831	2928	3009	3095	3191	3276	✓	✓			407
	Laccq + £298	129	141	157	170	184	198	209	224	238					
4,00 - 3,51	Fabric class 1	2883	3099	3190	3406	3497	3576	3790	3881	4097	✓	✓	*		443
	Fabric class 2	2982	3245	3339	3603	3694	3773	4037	4129	4392	✓	✓	*		443
	Fabric class 3	3062	3367	3458	3762	3855	3933	4236	4326	4631	✓	✓	*		443
	No Fabric	2615	2700	2799	2883	2981	3062	3149	3247	3332	✓	✓	*		443
	Laccq + £298	137	152	165	178	194	206	220	234	246					
4,50 - 4,01	Fabric class 1	2968	3198	3290	3522	3614	3690	3920			✓	✓	✓	*	488
	Fabric class 2	3078	3364	3456	3743	3834	3910	4197			✓	✓	✓	*	488
	Fabric class 3	3166	3497	3591	3920	4013	4089	4421			✓	✓	✓	*	488
	No Fabric	2667	2757	2853	2938	3037	3118	3204			✓	✓	✓	*	488
	Laccq + £298	151	163	176	191	203	216	231			✓	✓	✓	*	488
5,00 - 4,51	Fabric class 1	3140	3388	3479	3726	3819	3897			✓	✓	✓	✓	525	
	Fabric class 2	3263	3572	3665	3974	4064	4141			✓	✓	✓	✓	525	
	Fabric class 3	3362	3720	3811	4169	4262	4339			✓	✓	✓	✓	525	
	No Fabric	2819	2906	3003	3089	3188	3268			✓	✓	✓	✓	525	
	Laccq + £298	160	172	186	200	212	226			✓	✓	✓	✓	525	

Motor	Sunea io + Situio 1 io	included								
	Orea WT + switch	-135	-135	-135	-135	-135	-135	-135	-135	-135

Additional set-up cost of £298

Features and benefits



- Elegant yet robust design.
- Wind and water resistant thanks to ZIP-screen technology.
- Option wall mounting is not possible!
- LED lighting not possible.

Colours

Standard Colours



Other RAL-colours see table



Brustor Preferred List

91

Special finish 90

Options



Sensors

Patio heater 2000W / 2200W

81

82



Sensors

Patio heater 2000W

81

82



Orea WT with switch

Table

Fabrics

Fabric class 1

Brustor Acryl Collection
Dickson Orchestra
Sattler Elements Solids 314 (stock fabrics)
Soltis 86 (max width 4,4m)

Fabric class 2

Swela Elegance
Sattler Lumera Landscape
Sattler Elements Solids 314

Fabric class 3

Soltis 92 (max width 4,4m)

glued in stripes of 0,6m

Dickson Orchestra
Swela Elegance

Horizontal welded

Soltis 86: max width 4,4m
Soltis 92: max width 4,4m

Technical info

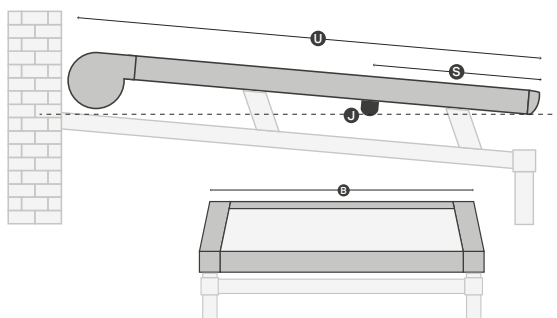

U Projection = max 5m S Position support beam: 1 standard when projection ≥ 3,01m / as from 4m = 0,5m B Width = max 6m L Extra support beam (prices see table, LED in option).
Trade Price March 2026 exc VAT.

B128 Conservatory awning

- Standard version delivered with 1 support beam from 3,01m projection.
- Glued fabrics
- With Somfy Sunea io motor
- Max fabric surface: 6m width x 5m projection

Projection (m) (fix + extension)	Width									
	2,01m - 2,50m	2,51m - 3,00m	3,01m - 3,50m	3,51m - 4,00m	4,01m - 4,50m	4,51m - 5,00m	5,01m - 5,50m	5,51m - 6,00m		
Somfy Sunea IO motor + Situio 1 IO pure										
1,50-0,50	Fabric class 1	3131	3244	3358	3473	3587	3702	3815	3930	
	Fabric class 2	3177	3301	3423	3548	3672	3797	3920	4045	
	Fabric class 3	3213	3346	3477	3609	3740	3873	4005	4135	
	Lacq + £298	109	121	135	149	162	173	188	201	
2,00-1,51	Fabric class 1	3224	3344	3465	3586	3708	3830	3950	4071	
	Fabric class 2	3281	3414	3548	3682	3815	3948	4083	4215	
	Fabric class 3	3328	3472	3615	3757	3902	4045	4188	4333	
	Lacq + £298	120	132	146	160	172	186	198	210	
2,50-2,01	Fabric class 1	3316	3444	3573	3701	3829	3957	4085	4212	
	Fabric class 2	3386	3530	3672	3815	3958	4102	4244	4387	
	Fabric class 3	3442	3598	3753	3908	4062	4216	4372	4526	
	Lacq + £298	128	140	157	167	182	195	208	221	
3,00-2,51	Fabric class 1	3409	3544	3681	3813	3948	4085	4220	4354	
	Fabric class 2	3492	3644	3797	3948	4102	4253	4407	4559	
	Fabric class 3	3558	3725	3890	4057	4224	4389	4556	4722	
	Lacq + £298	149	162	173	188	201	215	228	240	
3,50-3,01	Fabric class 1	3502	3644	3785	4020	4164	4309	4455	4599	
	Fabric class 2	3597	3759	3920	4176	4342	4508	4672	4837	
	Fabric class 3	3672	3850	4028	4303	4484	4667	4848	5029	
	Lacq + £298	149	162	173	188	201	215	228	240	
4,00-3,51	Fabric class 1	3596	3745	3984	4136	4287	4439	4591	4636	
	Fabric class 2	3702	3873	4139	4313	4488	4662	4837	4901	
	Fabric class 3	3788	3977	4263	4456	4649	4842	5035	5113	
	Lacq + £298	160	172	186	198	210	226	239	251	
4,50-4,01	Fabric class 1	3775	3934	4093	4251	4412	4569	4728	4778	
	Fabric class 2	3897	4081	4266	4449	4634	4818	5002	5073	
	Fabric class 3	3993	4198	4404	4608	4814	5018	5222	5309	
	Lacq + £298	167	182	195	208	221	233	246	260	
5,00-4,51	Fabric class 1	3871	4036	4202	4368	4533	4699	4980	5154	
	Fabric class 2	4004	4198	4392	4586	4779	4972	5276	5477	
	Fabric class 3	4109	4325	4543	4761	4977	5194	5514	5740	
	Lacq + £298	178	193	204	217	231	244	258	270	
Motor	Sunea io + Situio 1 io	included								
	Orea WT + switch	-135	-135	-135	-135	-135	-135	-135	-135	

Ⓢ No LED-strip included! Ⓣ Additional set-up cost of £298 regardless of the dimensions and quantity.

Surcharge brackets

Support	Adjustable	Ordered initially	Seperate order
D (adjustable)	106 - 165 mm	£ 29 / piece	£ 44/ piece
E (telescopic)	up to 500 mm	£ 41 / piece	£ 55 / piece

Brackets

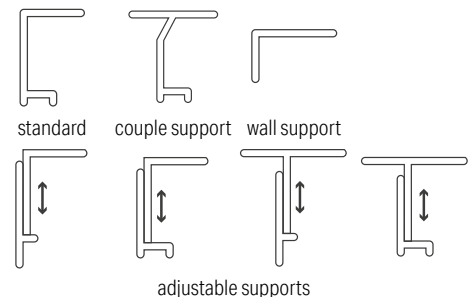

- Compact design (box 135 x 150 mm) and slim guide (65 x 75 mm).
- Max. dimensions: 6m wide x 5m projection
- Perfectly taut fabric and no light leaking through thanks to ZIP screen technology
- With Somfy Sunea IO control
- Optional dimmable white LED lighting in the box with integrated control

- Ease of installation, belt is pre-mounted
- Easy access for fabric and motor replacement
- Fabric at the bottom in guide
- All wheels on bearings

Colours

Standard Colours



Other RAL-colours see table



Brustor Preferred List **91**

Special finish **90**



Technical info

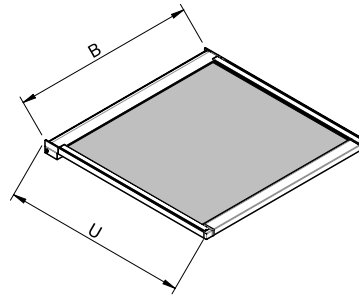

B = Width = max 6m
U = Projection = max 5m

Fabrics

Fabric class 1

- Brustor Acryl Collection **1**
- Dickson Orchestra **1**
- Sattler Elements **1** (stock fabrics)
- Sattler Elements Oeko Weave **1**
- Soltis 86 (max. width 4,40m, max surface 19m²) **3**

Fabric class 2

- Swela Elegance **1**
- Sattler Elements **1**

Fabric class 3

- Soltis 92 (max width 4,40m, max surface 18m²) **3**

1 uni fabrics standard stitched in stripes of 0,6 m*

2 horizontally welded

*Motif fabrics always in strips of 1.2m

3 horizontally welded

Projection(m)	Width	2,00m	2,01m - 2,50m	2,51m - 3,00m	3,01m - 3,50m	3,51m - 4,00m	4,01m - 4,50m	4,51m - 5,00m	5,01m - 5,50m	5,51m - 6,00m
		Somfy Sunea IO motor + Situio 1 io pure								
1,50 - 0,50	Fabric class 1	2430	2533	2639	2742	2843	2960	3065	3169	3271
	Fabric class 2	2442	2548	2657	2763	2867	2988	3096	3203	3308
	Fabric class 3	2467	2580	2696	2809	2921	3049	3165	3278	3389
	Lacq 2 + £298 3	78	88	98	109	119	132	143	156	168
2,00 - 1,51	Fabric class 1	2504	2613	2726	2838	2947	3073	3186	3296	3405
	Fabric class 2	2522	2636	2756	2870	2985	3114	3232	3348	3461
	Fabric class 3	2562	2688	2818	2943	3068	3208	3338	3464	3589
	Lacq 2 + £298 3	86	94	104	116	125	138	151	162	175
1,50 - 0,50	Fabric class 1	2576	2695	2817	2934	3051	3183	3304	3422	3539
	Fabric class 2	2601	2726	2854	2978	3101	3241	3369	3493	3617
	Fabric class 3	2656	2796	2938	3078	3216	3370	3512	3650	3789
	Lacq 2 + £298 3	93	101	111	122	133	145	157	170	182
2,00 - 1,51	Fabric class 1	2650	2776	2904	3030	3155	3294	3423	3548	3673
	Fabric class 2	2680	2814	2951	3085	3220	3367	3504	3638	3770
	Fabric class 3	2749	2903	3058	3211	3363	3530	3685	3837	3989
	Lacq 2 + £298 3	98	108	118	129	139	153	163	177	189
2,50 - 2,01	Fabric class 1	2723	2856	2992	3126	3258	3406	3542	3674	3807
	Fabric class 2	2760	2904	3050	3194	3335	3493	3640	3783	3925
	Fabric class 3	2843	3010	3179	3345	3510	3689	3858	4024	4190
	Lacq 2 + £298 3	104	115	124	136	146	159	171	183	196
3,00 - 2,51	Fabric class 1	2796	2936	3081	3222	3360	3517	3660	3800	3941
	Fabric class 2	2840	2992	3148	3301	3452	3619	3775	3927	4079
	Fabric class 3	2938	3117	3300	3479	3656	3850	4032	4211	4388
	Lacq 2 + £298 3	111	122	132	142	155	165	178	191	202
3,50 - 3,01	Fabric class 1	2869	3017	3168	3317	3464	3627	3779	3927	4074
	Fabric class 2	2919	3081	3246	3409	3568	3745	3911	4072	4233
	Fabric class 3	3032	3224	3419	3612	3803	4009	4205	4397	4589
	Lacq 2 + £298 3	119	129	139	149	161	173	185	197	209
4,00 - 3,51	Fabric class 1	2943	3097	3258	3413	3568	3738	3897	4053	4208
	Fabric class 2	2999	3169	3345	3516	3686	3871	4046	4217	4387
	Fabric class 3	3126	3332	3540	3746	3950	4169	4378	4583	4788
	Lacq 2 + £298 3	125	136	146	157	168	179	193	204	217
4,50 - 4,01	Fabric class 1	3015	3178	3346	3509	3672	3850	4017	4181	4343
	Fabric class 2	3079	3259	3442	3623	3803	3997	4182	4361	4541
	Fabric class 3	3220	3438	3660	3879	4097	4330	4551	4771	4987
	Lacq 2 + £298 3	133	143	155	164	176	187	200	210	223
5,00 - 4,51	Fabric class 1	3089	3260	3434	3604	3775	3960	4135	4305	4477
	Fabric class 2	3158	3348	3541	3730	3919	4124	4317	4506	4695
	Fabric class 3	3313	3545	3782	4013	4244	4490	4724	4958	5187
	Lacq 2 + £298 3	140	152	162	172	183	195	206	218	230

LED Lighting B129

Compose
your lighting
system



Colour temperature white LED-strip

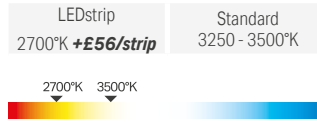

1 Led in the box

	Width	3m	4m	5m	6m
White	excl. control	155	216	278	340

CONTROL WHITE LED LIGHTING 

Somfy io control for one lighting system:

Surcharge of £435





The **B128** as a Pergola is a combination of awning and pergola for all year round outdoor living and easy to install. The retracting roof enables all year round use and with optional side and front screens offers an enclosed area. Add in LED frame lighting or a heater and you have an ambient living space.

The **B128** for conservatory or glass roofs is an easy to install shade system where heat build up and UV glare is a problem over modern glass roof living spaces.

Ask for our easy to follow order form.

B128 Pergola



B128 Conservatory



B128 Pergola



- Elegant and yet solid design.
- Wind and water resistant thanks to ZIP-screen technology.
- Integrated drainage through the supporting posts (standard 2,4m high)
- Optional water-repellent wall connection.
- Lean-to version: watertightness of the space between the wall and the pergola is not Brustor's responsibility.
- Invisibly integrated terrace mounting with foot support in supporting poles (standard)

- Supplied as standard with 1 support beam from 3,01 m extension. (see table)
- LED strips available in guides, poles and support beam(s).
- Glued fabrics in stripes of 60cm (only uni)
- Fitted with Somfy Sunea io motor
- Max fabric surface: 6m width x 5m projection

Options

Pole higher than 2400mm **£ 133**
 Build on B1100 Zip-screens **57**
 Wall connection **Table**
 Coupled (2 x pergola) **- £62**



LED (dimmable) + Situio 5 io **Table**
 Sensors **81**
 Patio heater 2000W / 2200W **82**



LED + Situio **Table**
 Sensors **81**
 Patio heater 2000W **82**



LED (dimmable) **Table**

Extra and special brackets / piece

Long end fixing bracket 50cm (piece) **£95**
 Long end fixing bracket 70cm (piece) **£115**
 Ceiling bracket 10cm (piece) **£129**

Colours

Standard Colours



Popular RAL-Colours



**RAL9004, RAL9005,
 RAL9011 & RAL9017**
 black satin not available

Brustor Preferred List
91

Special finish **90**

90

Anchoring

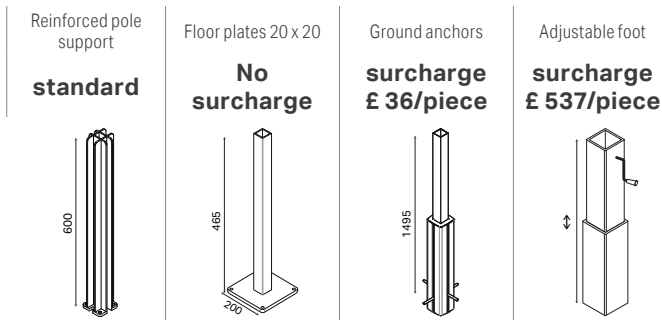

Technical info

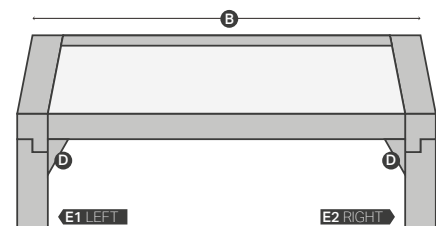
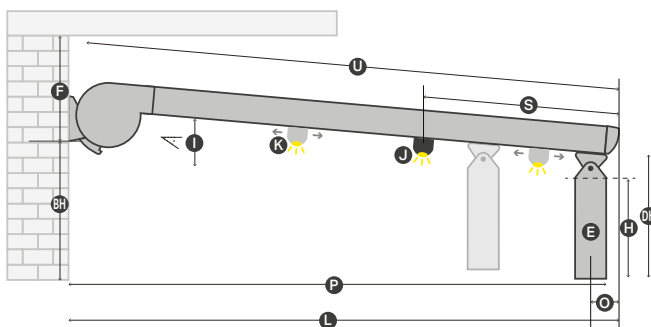

- B** Width: max 6m
- U** Projection = max 5m
- L** Length (Horizontal extension)
- P** Max 4,5m
- BH** Mounting height
- PH** Passage height
- S** Position support beam: see **J**
- I** Standard support beam from $\geq 3,01m = 0,75 /$ from 4m $S = 0,5m$
- D** Drainage at the post
- E** Pole
- F** Min 27cm free space between ceiling and bottom bracket.

- H** Pole height: Standard max 2,4m / max 3m with surcharge. when higher than 2400mm = **£133/piece**
- I** Slope: min 15cm/m (9°) / max 65cm/m (33°)
- K** Extra support beam (with extra light)
- O** Pole position: Max 1m inside or max 1/3 of the extension.

B128 Pergola

		B Width								Triangular fabric Serge 600 A
		2,00m - 2,50m	2,51m - 3,00m	3,01m - 3,50m	3,51m - 4,00m	4,01m - 4,50m	4,51m - 5,00m	5,01m - 5,50m	5,51m - 6,00m	
U Projection (m)		Somfy Sunea IO motor + Situio 1 IO pure								
1,50 - 0,50	Fabric class 1	3933	4047	4161	4275	4389	4504	4618	4733	507 G
	Fabric class 2	3979	4102	4227	4351	4475	4599	4722	4847	
	Fabric class 3	4015	4148	4279	4412	4542	4674	4807	4938	
	Lacq C + £298 L	109	121	135	149	162	173	188	201	
2,00 - 1,51	Fabric class 1	4026	4146	4268	4388	4511	4632	4752	4875	617
	Fabric class 2	4084	4216	4351	4484	4618	4751	4885	5018	
	Fabric class 3	4130	4273	4417	4560	4703	4847	4990	5134	
	Lacq C + £298 L	120	132	146	159	172	186	197	210	
2,50 - 2,01	Fabric class 1	4120	4247	4375	4503	4631	4759	4887	5015	741
	Fabric class 2	4189	4333	4475	4618	4761	4903	5046	5190	
	Fabric class 3	4245	4400	4555	4710	4864	5019	5174	5328	
	Lacq C + £298 L	128	140	157	167	180	195	207	221	
3,00 - 2,51	Fabric class 1	4211	4346	4482	4616	4751	4887	5023	5155	507 G
	Fabric class 2	4295	4446	4599	4751	4903	5056	5208	5361	
	Fabric class 3	4360	4526	4693	4859	5026	5192	5359	5526	
	Lacq C + £298 L	149	162	173	188	201	215	228	239	
3,50 - 3,01	Fabric class 1	4304	4446	4588	4822	4966	5111	5257	5401	617
	Fabric class 2	4400	4562	4722	4980	5144	5310	5474	5639	
	Fabric class 3	4475	4653	4829	5106	5286	5468	5651	5830	
	Lacq C + £298 L	149	162	173	193	204	219	233	244	
4,00 - 3,51	Fabric class 1	4398	4548	4786	4939	5089	5241	5393	5438	741
	Fabric class 2	4504	4675	4941	5115	5289	5465	5639	5704	
	Fabric class 3	4590	4778	5066	5258	5452	5644	5837	5916	
	Lacq C + £298 L	159	172	189	201	215	230	243	250	
4,50 - 4,01	Fabric class 1	4576	4736	4896	5054	5214	5370	5530	5580	2* support beam included
	Fabric class 2	4699	4883	5067	5252	5436	5620	5804	5874	
	Fabric class 3	4795	5000	5206	5411	5615	5821	6025	6111	
	Lacq C + £298 L	171	185	198	212	224	238	251	260	
5,00 - 4,51	Fabric class 1	4673	4839	5004	5171	5336	5501	5614	5783	2* support beam included
	Fabric class 2	4806	5000	5194	5388	5581	5775	5901	6098	
	Fabric class 3	4912	5129	5346	5563	5779	5996	6134	6351	
	Lacq C + £298 L	180	195	208	223	235	248	249	262	
Motor	Sunea io + Situio 1 io								Included	
Valance	Soltis 86 (1m, RTS motor)	1528	1571	1636	1669	1735	1766			
	Soltis 92	1546	1626	1699	1740	1816	1856			

Additional fabric support A L	147	160	172	186	199	210	224	237
Wall cover profile	134	146	157	173	184	195	208	221
Horizontal reinforcement bar			276	307	338	368	399	431

A Price not applicable for reorder! C Additional set-up cost of £298 regardless of the dimensions and quantity. G Minimum width side screen: 80cm.
 L No LED-strip included!

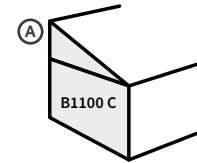

Price triangular fabric in combination with a B1100C screen 57 to close the side.

LED in poles **not** possible in combination with a side screen.

Fabrics

Fabric class 1

Bruster Acryl Collection
 Dickson Orchestra
 Sattler Elements Solids 314 (stock fabrics)
 Soltis 86 (max width 4,4m)

Fabric class 2

Swela Elegance
 Sattler Lumera Landscape
 Sattler Elements Solids 314

Fabric class 3

Soltis 92 (max width 4,4m)

Swela Elegance Perla (320gr/m²)

370 07 Rosy
 370 08 Jack
 370 09 Nirvana
 370 18 Logan
 370 28 Rocco
 370 37 Sienna
 370 57 Oscar

Swela Elegance Perla fabric not from stock list = + £21/m² on fabric class1

Coupled

Can be joined together by means of a special couple pole. Price calculation: 2 pergolas - £60 for the couple pole which replaces 2 standard poles.

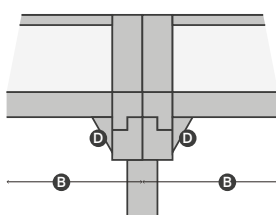

Pole for coupling

Wall connection

See table

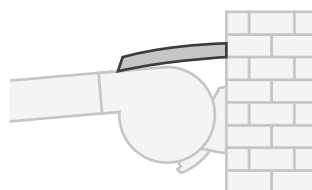

Optional water repellent wall connection

Motorised valance

Valance of 1m works on solar panel + battery.

⚠ Risk of wrinkle formation in the valance when using maximum dimensions.

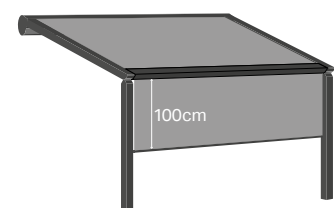

LED Lighting B128

Compose
your lighting
system

LIGHTING + CONTROL = LIGHTING SYSTEM

Colour temperature white LEDstrip

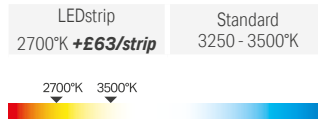

1 Led in support beam

	Width	3m	4m	5m	6m
White	excl. control	154	215	276	338
RGB	excl. control	350	480	609	735

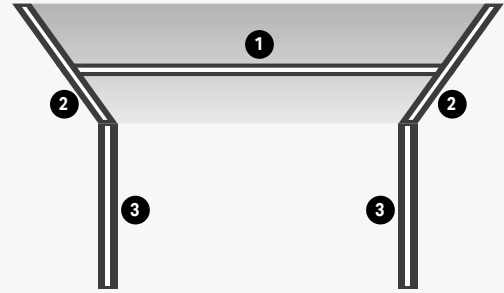

2 Led in both side rails

	Projection	3m	4m	5m
White	excl. control	336	453	570
RGB	excl. control	840	848	1101

3 Led in both poles

White	excl. control	346
--------------	---------------	-----



CONTROL WHITE LED LIGHTING



Somfy io control for one to four types of lighting:

Supplement of £565

- Max of 48m LED strip or combination of 4 channels available
- 4 channels of up to max. 9m

CONTROL RGB LIGHTING



Somfy io control for RGB LED-strip up to max 16m:

Supplement of £809

- *Situo 5 Var not included*

CONTROL WHITE LED LIGHTING



Brustor dimmable

Surcharge of £342

- 1 channel of max 12m LED strip
- Brustor remote included

Surcharge of £550

- 1 channel of max 20m LED strip
- Brustor remote included

CONTROL RGB LIGHTING



Brustor LED control for RGB LED-strip up to max 16m:

Surcharge of £322

- Brustor remote included

B128 XL

Features and benefits



- Elegant yet sturdy design.
- Wind and water resistant thanks to ZIP-screen technology.
- Integrated drainage through the front support poles (standard height 2.5m)
- Standard wall connection.
- The watertightness of the strip between wall and pergola is not the responsibility of Brustor.
- Invisibly integrated patio fixing in the support poles (standard)
- Optional integrated screens
- Optional doorpole

- Supplied as standard with 1 support beam from 3,01 m extension. (see table)
- LED strips available in guides, poles and support beam(s).
- Glued fabrics in stripes of 60cm (only uni)
- Fitted with Somfy Sunea io motor
- Max fabric surface: 30m² (6m x 5m of 5m x 6m)

Options

Doorpole
Pole higher than 2500mm
Wall connection



LED (dimnable) + Situio 5 io
Sensors

£407/pc
£133
Included

Table
81

Colours

Standard Colours



Popular RAL colours



**RAL9004, RAL9005,
RAL9011 & RAL9017
black satin not
available**

Brustor Preferred List
91

Special finish

90

Drainage & Anchoring

	Pole support standard	Reinforced pole support surcharge £168/piece	Floor plate 20 x 20 surcharge £99/piece	Corner Floor plate 20 x 20 surcharge £99/piece	Ground anchor surcharge £125/piece	Couple pool foot included with door or couple pole	Reinforced couple pole support surcharge with door or couple pole £168/piece
1 Drainage at the bottom of the pole	<input checked="" type="checkbox"/>	<input checked="" type="checkbox"/>	<input checked="" type="checkbox"/>	<input checked="" type="checkbox"/>	<input checked="" type="checkbox"/>	<input checked="" type="checkbox"/> A	<input checked="" type="checkbox"/> A
2 Drainage trough anchoring	<input checked="" type="checkbox"/>	<input checked="" type="checkbox"/>	<input checked="" type="checkbox"/>	<input checked="" type="checkbox"/>	<input checked="" type="checkbox"/>	<input checked="" type="checkbox"/> A	<input checked="" type="checkbox"/> A
3 Optional drainage (sideways)	<input checked="" type="checkbox"/>	<input checked="" type="checkbox"/>	<input checked="" type="checkbox"/>	<input checked="" type="checkbox"/>	<input checked="" type="checkbox"/>	<input checked="" type="checkbox"/> A	<input checked="" type="checkbox"/> A

A only with couple pole

B128 XL

B128 XL combines the best of two worlds: a pergola with built-in screens that completely disappear into the structure. This way, you can enjoy the advantages of an awning in combination with the advantages of a patio roof. The B128 XL is always attached to the house. The fabric is rolled up electrically thanks to the durable ZIP screen technology and remains tightly stretched, year after year. Sharing frame design from our louvered roof B200XL structure.

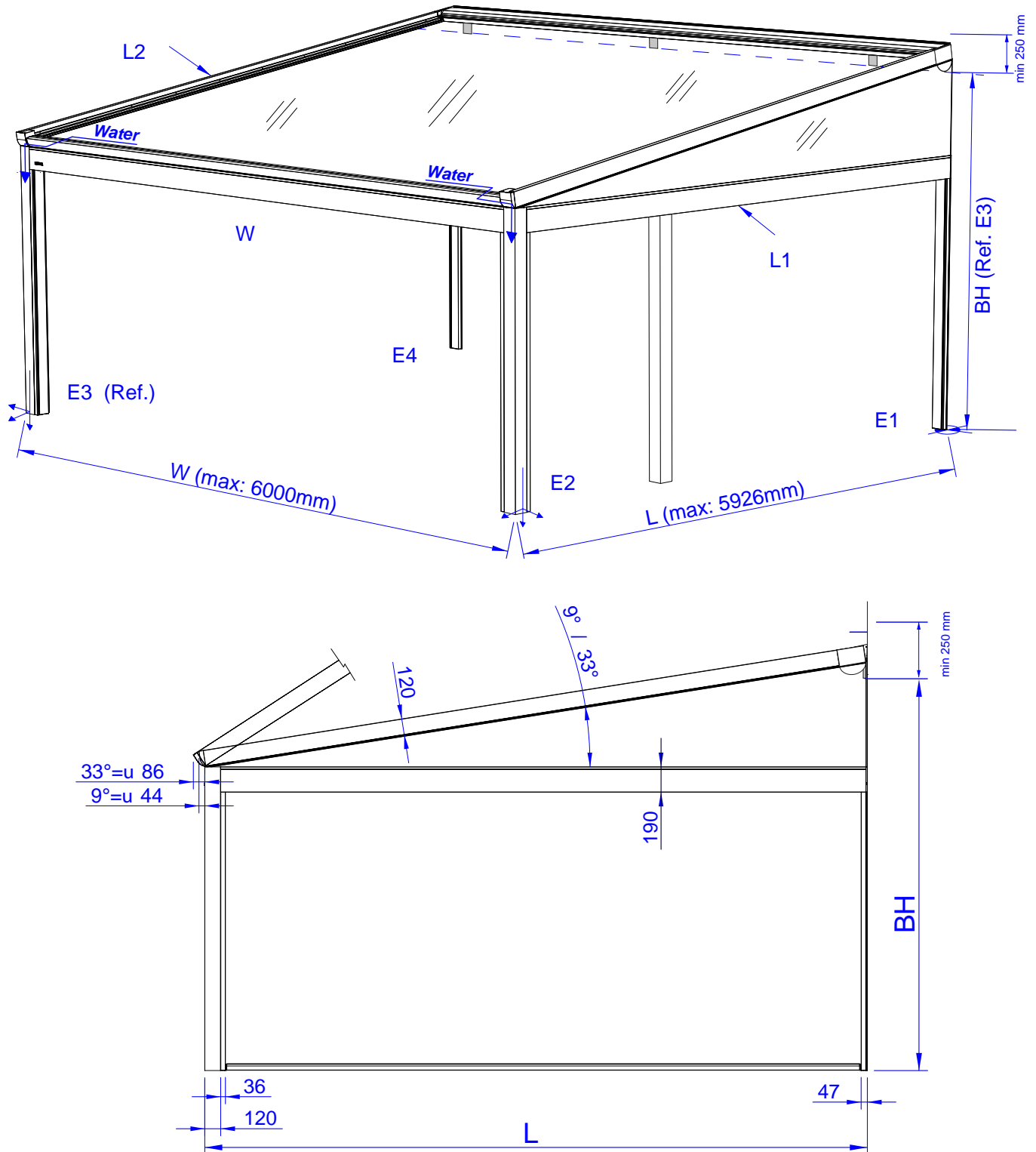

Maximum projection is 6000mm. Horizontal projection max 5926mm.
 Width max: 6000mm with a maximum fabric surface of 30m².
 Inclination between 9° and 33°. Standard height: 2500mm (passage height: 2310mm).

All pole heights, wall rails and wall brackets are determined in relation to reference height E3 (Ref). The mounting height is measured from the bottom of the wall bracket. From the bottom of the wall bracket, a 250mm space above must be kept free to allow the fabric to be replaced.

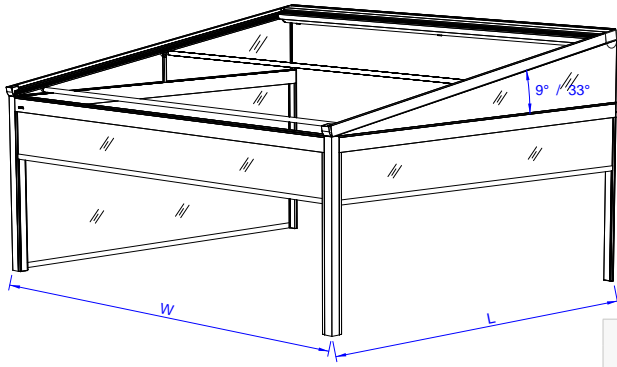

Fabrics

Uni fabrics glued in stripes of 0,6m

Fabric class 1

 Brustor Acryl Collection
 Dickson Orchestra
 Sattler Elements Solids 314 (fabrics on stock)
 Soltis 86 (max width 4,40m)

Fabric class 2



 Swela Elegance
 Sattler Lumera Landscape
 Sattler Elements Solids 314





















Fabric class 3

 Dickson Orchestra MAX
 Soltis 92 (max width 4,40m)
 Swela Elegance Perla (320gr/m²)
 370 08 Jack
 370 09 Nirvana
 370 18 Logan
 370 28 Rocco
 370 37 Sienna
 370 57 Oscar

 Swela Elegance Perla fabric not from stock list =
 + £21/m² on fabric class 1

Maximum screen dimensions











- All fabrics up to 3m height (height > 2,5m is 1 extra welding seam visible). Some references possible up to 3m without welding seam (see p. 4).
- Sergé 600 and Sergé 1% up to 6,07m
- Soltis 86/92: up to 4,4m width
-  no warranty on folds formation In Soltis fabric.
- B** A transparent PVC-window is only possible with screenfabric.
-  no warranty on folds formation and scratches in PVC-window.

		Width (W)						
		2,51m - 3,00m	3,01m - 3,50m	3,51m - 4,00m	4,01m - 4,50m	4,51m - 5,00m	5,01m - 5,50m	5,51m - 6,00m
Length/Projection (L)	Width (W)	Somfy Sunea IO motor + Situio 1 io pure						
	1,50-0,50	Fabric class 1	6866	7041	7215	7398	7573	7746
Fabric class 2		6890	7068	7245	7433	7612	7790	7969
Fabric class 3		6924	7108	7293	7486	7670	7854	8039
Lacq  + £298 		112	129	149	165	184	202	221
2,00-1,51	Fabric class 1	6967	7151	7335	7526	7709	7891	8077
	Fabric class 2	7000	7188	7377	7575	7764	7952	8141
	Fabric class 3	7047	7243	7441	7648	7844	8041	8239
	Lacq  + £298 	149	172	196	221	245	269	293
2,50-2,01	Fabric class 1	7069	7261	7453	7655	7847	8038	8231
	Fabric class 2	7110	7308	7508	7717	7915	8115	8314
	Fabric class 3	7169	7379	7589	7808	8018	8228	8439
	Lacq  + £298 	184	215	245	276	306	335	367
3,00-2,51	Fabric class 1	7170	7371	7573	7782	7984	8185	8386
	Fabric class 2	7219	7429	7639	7858	8068	8278	8488
	Fabric class 3	7292	7514	7737	7970	8193	8415	8638
	Lacq  + £298 	221	258	293	330	367	403	439
3,50-3,01	Fabric class 1	7272	7523	7740	7966	8183	8398	8618
	Fabric class 2	7329	7590	7818	8054	8282	8508	8736
	Fabric class 3	7415	7692	7935	8185	8428	8670	8914
	Lacq  + £298 	258	300	343	385	427	469	513
4,00-3,51	Fabric class 1	7373	7633	7861	8094	8321	8544	8772
	Fabric class 2	7440	7711	7950	8196	8433	8670	8910
	Fabric class 3	7537	7826	8083	8346	8602	8856	9112
	Lacq  + £298 	293	343	390	439	488	536	586
4,50-4,01	Fabric class 1	7475	7743	7979	8223	8457	8692	8928
	Fabric class 2	7550	7832	8081	8337	8586	8834	9082
	Fabric class 3	7660	7962	8231	8507	8776	9042	9312
	Lacq  + £298 	330	385	439	494	550	603	659
5,00-4,51	Fabric class 1	7576	7854	8099	8350	8596	9128	9393
	Fabric class 2	7660	7952	8211	8478	8738	9286	9566
	Fabric class 3	7782	8098	8379	8668	8951	9520	9821
	Lacq  + £298 	367	427	488	550	609	670	731
5,50-5,01	Fabric class 1	0	8175	8452	8730	9004	9274	
	Fabric class 2	0	8284	8576	8872	9163	9448	
	Fabric class 3	0	8445	8761	9081	9397	9707	
	Lacq  + £298 	0	469	536	603	670	738	
5,92-5,51	Fabric class 1	0	8285	8571	8858	9142		
	Fabric class 2	0	8405	8708	9013	9315		
	Fabric class 3	0	8580	8910	9243	9570		
	Lacq  + £298 	0	513	586	659	731		
Motor	Sunea io + Situio 1 io	Included						
		Additional support beam required. Included in price.						
Additional support beam		160	172	186	199	210	224	237

 Additional set-up cost of £298 regardless of the dimensions and quantity.

		0,76 - 1,00	1,01 - 1,20	1,21 - 1,40	1,41 - 1,60	1,61 - 1,80	1,81 - 2,00	2,01 - 2,20	2,21 - 2,40	2,41 - 2,60	2,61 - 2,80		
ZIP SCREEN W 	Overall dimensions pergola	H ≤ 2,5 m	Sergé 600 Soltis 86 / Veozip	1269	1312	1351	1390	1432	1473	1514	1554	1596	1638
		Sergé 1% Soltis 92	1313	1356	1398	1440	1484	1527	1569	1611	1655	1699	
	H ≤ 3,0 m	Sergé 600 Soltis 86 / Veozip	1321	1368	1411	1458	1501	1548	1592	1638	1684	1729	
		Sergé 1% Soltis 92	1368	1416	1462	1510	1558	1605	1650	1699	1747	1793	
	PVC-window B	+ £142 nett	+ £142 nett	+ £142 nett	+ £142 nett	+ £142 nett	+ £142 nett	+ £142 nett	+ £142 nett	+ £142 nett	+ £142 nett		

*  Mainhousing required

		ZIP SCREEN L  Overall dimensions pergola			
		Total	H ≤ 2,5 m		H ≤ 3,00 m
		from - up to	Sergé 600 Soltis 86 Veozip	Sergé 1% Soltis 92 Veozip	Sergé 600 Soltis 86 Veozip
Mainhousing  L1 of L2 (per side)	1,50-0,50	349	1269	1313	1321
	2,00-1,51	422	1312	1356	1368
* Triangular side fabric  Sergé 600 incl. triangular support	2,50-2,01	498	1312	1356	1368
	3,00-2,51	571	1312	1356	1368
481	3,50-3,01	643	1312	1356	1368
	4,00-3,51	720	1312	1356	1368
658	4,50-4,01	792	1312	1356	1368
	5,00-4,51	865	1312	1356	1368
929	5,50-5,01	942	1312	1356	1368
	5,92-5,51	1002	1312	1356	1368
1243	1,01-1,20	481	1312	1356	1368
	1,21-1,40	481	1312	1356	1368
1277	1,41-1,60	481	1312	1356	1368
	1,61-1,80	481	1312	1356	1368
1277	1,81-2,00	481	1312	1356	1368
	2,01-2,20	481	1312	1356	1368
1277	2,21-2,40	481	1312	1356	1368
	2,41-2,60	481	1312	1356	1368
1277	2,61-2,80	481	1312	1356	1368
	2,81-3,00	481	1312	1356	1368
1277	3,01-3,20	481	1312	1356	1368
	3,21-3,40	481	1312	1356	1368
1277	3,41-3,60	481	1312	1356	1368
	3,61-3,80	481	1312	1356	1368
1277	3,81-4,00	481	1312	1356	1368
	4,01-4,20	481	1312	1356	1368
1277	4,21-4,40	481	1312	1356	1368
	4,41-4,60 	481	1312	1356	1368
1277	4,61-4,80 	481	1312	1356	1368
	4,81-5,00 	481	1312	1356	1368
1277	5,01-5,20 	481	1312	1356	1368
	5,21-5,40 	481	1312	1356	1368
1277	5,41-5,60 	481	1312	1356	1368
	5,61-5,80 	481	1312	1356	1368
1277	5,81-6,00 	481	1312	1356	1368
			1312	1356	1368

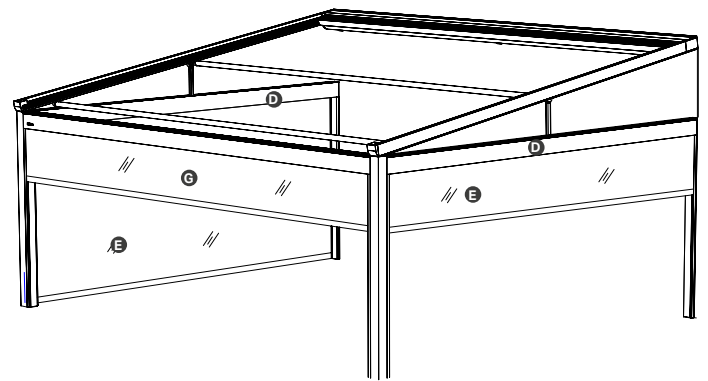
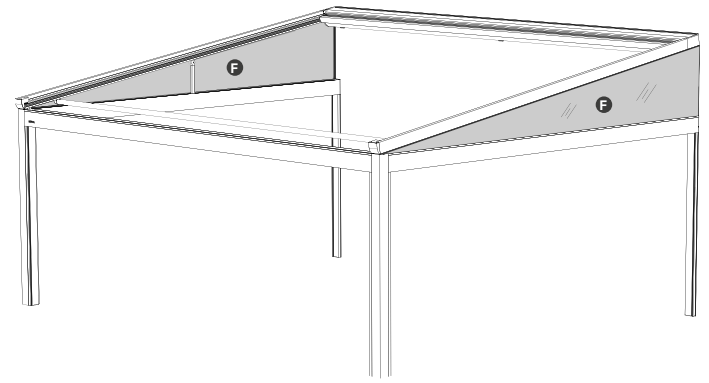

 Mainhousing cannot be ordered and fitted afterwards.

2,81-3,00	3,01-3,20	3,21-3,40	3,41-3,60	3,61-3,80	3,81-4,00	4,01-4,20	4,21-4,40	4,41-4,60	4,61-4,80	4,81-5,00	5,01-5,20	5,21-5,40	5,41-5,60	5,61-5,80	5,81-6,00
1680	1722	1762	1804	1852	1898	1942	1989	2041	2086	2130	2175	2222	2268	2316	2360
1743	1788	1829	1869	1932	1981	2027	2074	2125	2174	2218	2264	2313	2360	2406	2454
1774	1821	1865	1910	1955	2005	2054	2105	2159	2211	2261	2310	2360	2410	2462	2511
1839	1890	1937	1982	2041	2093	2145	2196	2253	2303	2356	2405	2456	2508	2559	2612
+ £191 nett	+ £191 nett	+ £191 nett	+ £191 nett	+ £191 nett	+ £191 nett	+ £331 nett	+ £331 nett	+ £331 nett	+ £331 nett	+ £331 nett	+ £331 nett	+ £331 nett	+ £331 nett	+ £331 nett	+ £331 nett



LED Lighting B128 XL

Compose
your lighting
system

LIGHTING



CONTROL



LIGHTING
SYSTEM

Colour temperature
white LEDstrip

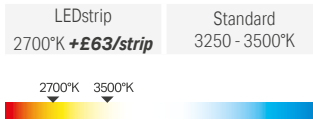

1 Led in support beam

	Width	3m	4m	5m	6m
White	excl. control	154	215	276	338
RGB	excl. control	350	480	609	735

2 Led in both side rails

	Projection	3m	4m	5m	6m
White	excl. control	336	453	570	758
RGB	excl. control	840	848	1101	1271

3 Dimmable LED Spot in mainhousing

£120/spot

4 Led on gutter UP/DOWN

Length	< 4m	< 6m	< 8m	< 10m	< 12m	< 14m	< 16m	< 18m	< 20m	< 22m
1 x white leds	1467	1689	1800	1827	1864	2099	2322	2432	2470	2518
1 x RGB leds	1581	1680	1916	2259	2297	2592	2692	2926	3136	3185
Length	< 24m	< 26m	< 28m	< 30m	< 32m	< 34m	< 36m	< 38m	< 40m	< 42m
1 x white leds	2778	2964	3012	3111	3322	3543	3753	3790	4024	4246
1 x RGB leds	3643	3765	3938	4098	4185	4467	4764	4801	5097	5197

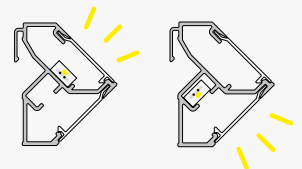

Length	< 4m	< 6m	< 8m	< 10m	< 12m	< 14m	< 16m	< 18m	< 20m	< 22m
2 x white leds	1675	2001	2215	2346	2407	767	3136	3198	3309	3407
White + RGB leds	2061	2399	2872	3024	3148	3271	3531	3716	4098	4296
2 x RGB leds	2446	2797	3530	3703	3795	3888	3924	4234	4888	5184
Length	< 24m	< 26m	< 28m	< 30m	< 32m	< 34m	< 36m	< 38m	< 40m	< 42m
2 x white leds	3740	3888	3950	4148	4370	4592	4826	4923	5217	5498
White + RGB leds	4814	5097	5295	5479	5578	5949	6269	7458	7893	8133
2 x RGB leds	5888	6306	6640	6718	6788	7306	7714	9994	10496	10767



CONTROL WHITE LED LIGHTING



Somfy io control for one to four types of lighting:

Supplement of £561

- Max of 48m LED strip or combination of 4 channels available
- 4 channels of up to max. 12m

CONTROL RGB LIGHTING



Somfy io control for RGB LED-strip up to max 16m:

Supplement of £809

- *Situo 5 Var not included*

B2100*

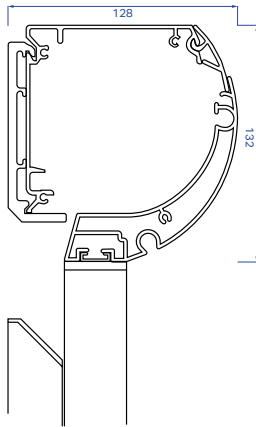

B2100
With adapter

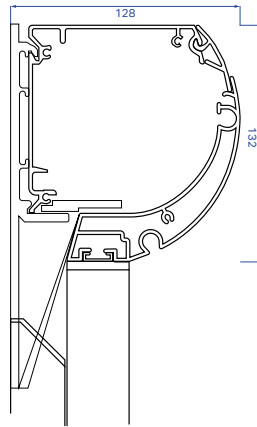

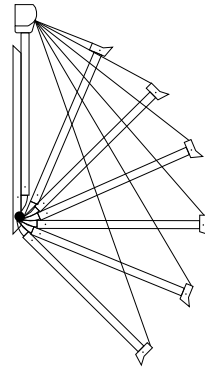

B2100
With Long end fixing bracket

- Drop arm awning with an inclination of 90° or 135°.
- Standard version delivered with motor.
- Max dimensions: width 5m (coupled: 6m)/ Projection 0,8 - 1,4m.
- △ Screen fabric limited height of 1,2m and max inclination of 90°.



90° or 135° inclination

		Width										
		0,65m - 0,80m	0,81m - 1,00m	1,01m - 1,20m	1,21m - 1,40m	1,41m - 1,60m	1,61m - 1,80m	1,81m - 2,00m	2,01m - 2,20m	2,21m - 2,40m	2,41m - 2,60m	2,61m - 2,80m
Projection (m) (fix + extension)		B2100 + Sunea io + situo 1 io • inclination 90° or 135°										
inclination 90°												
0,80m - 90°	Acryl class 1 & class 2	1007	1025	1042	1107	1132	1151	1172	1189	1207	1280	1296
	Soltis 86 / Acryl class 3 / Sergé	1017	1035	1053	1137	1163	1180	1196	1217	1233	1325	1344
	Sergé 1% / Soltis 92	1055	1073	1092	1180	1206	1225	1243	1264	1281	1377	1395
	No fabric	936	957	976	996	1024	1044	1065	1087	1105	1131	1152
1,00m - 90°	Acryl class 1 & class 2	1022	1039	1060	1132	1158	1176	1195	1215	1233	1316	1332
	Soltis 86 / Acryl class 3 / Sergé	1035	1053	1071	1168	1194	1211	1231	1248	1268	1372	1389
	Sergé 1% / Soltis 92	1073	1092	1113	1211	1239	1257	1278	1296	1316	1424	1442
	No fabric	943	963	984	1003	1028	1052	1071	1091	1112	1140	1161
1,20m - 90°	Acryl class 1 & class 2	1035	1055	1071	1158	1181	1202	1220	1241	1256	1350	1369
	Soltis 86 / Acryl class 3 / Sergé	1053	1071	1091	1202	1226	1245	1260	1280	1301	1416	1433
	Sergé 1% / Soltis 92	1092	1113	1131	1248	1274	1292	1311	1329	1351	1473	1489
	No fabric	948	969	987	1008	1039	1055	1077	1099	1120	1144	1166
1,40m - 90°	Acryl class 1 & class 2	1091	1107	1127	1222	1247	1266	1285	1302	1321	1423	1440
	Soltis 86 / Acryl class 3	1110	1129	1146	1274	1298	1314	1336	1351	1372	1500	1521
	Soltis 92	1151	1173	1190	1322	1349	1364	1388	1402	1424	1559	1581
	No fabric	995	1017	1039	1057	1085	1104	1125	1146	1167	1195	1210
inclination 135°												
0,80m - 135°	Acryl class 1 & class 2	1017	1036	1056	1131	1157	1174	1195	1214	1231	1316	1333
	Soltis 86 / Acryl class 3	1033	1050	1070	1169	1195	1211	1231	1249	1270	1375	1392
	Soltis 92	1070	1091	1112	1214	1241	1257	1278	1297	1318	1428	1447
	No fabric	936	957	976	996	1024	1044	1065	1087	1105	1131	1152
1,00m - 135°	Acryl class 1 & class 2	1035	1055	1071	1163	1184	1206	1225	1244	1260	1358	1378
	Soltis 86 / Acryl class 3	1039	1056	1076	1179	1203	1223	1241	1256	1277	1385	1403
	Soltis 92	1094	1115	1132	1254	1281	1301	1321	1339	1358	1487	1508
	No fabric	943	963	984	1003	1028	1052	1071	1091	1112	1140	1161
1,20m - 135°	Acryl class 1 & class 2	1055	1070	1091	1195	1217	1239	1254	1274	1292	1401	1420
	Soltis 86 / Acryl class 3	1077	1098	1115	1249	1276	1294	1312	1330	1349	1490	1506
	Soltis 92	1120	1139	1159	1297	1325	1344	1361	1382	1401	1549	1566
	No fabric	948	969	987	1008	1039	1055	1077	1099	1120	1144	1166
1,40m - 135°	Acryl class 1 & class 2	1110	1129	1147	1264	1287	1308	1325	1344	1360	1485	1503
	Soltis 86 / Acryl class 3	1120	1137	1158	1285	1312	1330	1349	1369	1385	1523	1541
	Soltis 92	1183	1204	1220	1382	1409	1426	1446	1463	1483	1653	1670
	No fabric	995	1017	1039	1057	1085	1104	1125	1146	1167	1195	1210
Motor	Sunea io + Situio 1 io	included										
	Orea WT + switch	-117	-117	-117	-117	-117	-117	-117	-117	-117	-117	-117
Valance	Straight valance	41	41	41	50	50	50	50	50	50	56	56
	Waved valance	53	53	53	60	60	60	60	60	60	71	71
	Lacq  + £298 	120	121	125	129	131	135	137	142	149	151	156

Ⓢ Additional set-up cost of £298. Independently from dimensions or quantities.

Options

Brackets to mount in window opening (only with motor)
 Long end fixing bracket per screen

£62
 £45

*B2100



Sensors



Orea WT + switch

Supports / width

Width	< 2,5m	≥ 2,5m
support 15cm	2	3

81

Colours

Table

Standard Colours



Other RAL-colours see table





Brustor Preferred List

91

Special finish

90

Projection (m) (fix + extension)		Width										
		2,81m - 3,00m	3,01m - 3,20m	3,21m - 3,40m	3,41m - 3,60m	3,61m - 3,80m	3,81m - 4,00m	4,01m - 4,20m	4,21m - 4,40m	4,41m - 4,60m	4,61m - 4,80m	4,81m - 5,00m
B2100 + Sunea io + situo 1 io • inclination 90° or 135°												
inclination 90°												
0,80m - 90°	Acryl class 1 & class 2	1317	1334	1354	1420	1437	1458	1489	1506	1521	1539	1556
	Soltis 86 / Acryl class 3 / Sergé	1360	1381	1397	1484	1500	1520	1552	1566	1586	1603	1617
	Sergé 1% / Soltis 92	1414	1434	1452	1541	1559	1580	1611	1629	1648	1665	1683
	No fabric	1174	1196	1215	1235	1256	1276	1312	1329	1351	1365	1388
1,00m - 90°	Acryl class 1 & class 2	1351	1370	1389	1463	1483	1501	1532	1552	1566	1583	1603
	Soltis 86 / Acryl class 3 / Sergé	1409	1425	1442	1541	1562	1578	1610	1629	1643	1662	1677
	Sergé 1% / Soltis 92	1462	1482	1501	1602	1623	1640	1673	1692	1708	1726	1745
	No fabric	1179	1201	1220	1243	1262	1280	1318	1334	1354	1373	1392
1,20m - 90°	Acryl class 1 & class 2	1386	1403	1423	1506	1529	1544					
	Soltis 86 / Acryl class 3 / Sergé	1454	1473	1490	1603	1617	1637					
	Sergé 1% / Soltis 92	1509	1531	1549	1665	1684	1701					
	No fabric	1183	1206	1228	1247	1270	1287					
1,40m - 90°	Acryl class 1 & class 2	1461										
	Soltis 86 / Acryl class 3	1538										
	Soltis 92	1598										
	No fabric	1235										
inclination 135°												
0,80m - 135°	Acryl class 1 & class 2	1353	1372	1389	1466	1485	1505	1536	1553	1569	1585	1605
	Soltis 86 / Acryl class 3	1373	1391	1410	1498	1515	1531	1564	1581	1598	1615	1633
	Soltis 92	1466	1484	1506	1610	1629	1648	1682	1698	1714	1731	1750
	No fabric	1174	1196	1215	1235	1256	1276	1312	1329	1351	1365	1388
1,00m - 135°	Acryl class 1 & class 2	1396	1415	1433	1521	1541	1559	1589	1610	1627	1644	1658
	Soltis 86 / Acryl class 3	1468	1487	1504	1626	1642	1662	1692	1708	1726	1742	1760
	Soltis 92	1527	1544	1564	1689	1708	1726	1759	1776	1795	1812	1832
	No fabric	1179	1201	1220	1243	1262	1280	1318	1334	1354	1373	1392
1,20m - 135°	Acryl class 1 & class 2	1439	1458	1474	1580	1598	1613					
	Soltis 86 / Acryl class 3	1528	1545	1564	1700	1718	1737					
	Soltis 92	1588	1607	1627	1767	1788	1809					
	No fabric	1183	1206	1228	1247	1270	1287					
1,40m - 135°	Acryl class 1 & class 2	1520										
	Soltis 86 / Acryl class 3	1626										
	Soltis 92	1689										
	No fabric	1235										
Motor	Sunea io + Situio 1 io						included					
	Orea WT + switch	-117	-117	-117	-117	-117	-117	-117	-117	-117	-117	-117
Valance	Straight valance	56	56	56	75	75	75	75	75	75	82	82
	Waved valance	71	71	71	93	93	93	93	93	93	103	103
	Lacq  + £298 	158	163	166	170	173	176	179	186	188	194	196

Additional set-up cost of £298. Independently from dimensions or quantities.

B2100 2 parts: 3 arms*

Features and benefits



- Projection awnings with fixed arm and inclination of 90° or 135°.
- Standard version delivered with motor.
- Max dimensions: 5m width (coupled: 6m)/ Projection 0,8 - 1,4m.
- △ Screenfabric limited up to 12m height and max inclination of 90°.

Supports / width

Width	< 2,5m	2,5 - 4m	≥ 4,0m
support 15cm	2	3	4

Colours

Standard Colours



Other RAL-colours
see table



Brustor Preferred List

91

Special finish

90

Options

Brackets to mount in window opening
(only with motor)

Long end fix bracket (per screen)



Sensors



Orea WT + switch

£62

£45

81

Table

		Width										
		1,61m - 2,00m	2,01m - 2,40m	2,41m - 2,80m	2,81m - 3,20m	3,21m - 3,60m	3,61m - 4,00m	4,01m - 4,40m	4,41m - 4,80m	4,81m - 5,20m	5,21m - 5,60m	5,61m - 6,00m
Projection (m) (fix + extension)		B2100 + Sunea io + sitio 1 io • inclination 90° or 135°										
inclination 90°												
0,80m-90°	Acryl class 1 & class 2	1472	1509	1642	1691	1728	1764	1804	1838	1982	2023	2060
	Soltis 86 / Acryl class 3 / Sergé	1495	1535	1700	1752	1788	1824	1862	1899	2077	2115	2152
	Sergé 1% / Soltis 92	1557	1596	1771	1824	1861	1900	1937	1976	2162	2204	2242
1,00m-90°	No fabric	1287	1327	1365	1418	1456	1495	1536	1573	1627	1666	1707
	Acryl class 1 & class 2	1500	1537	1688	1737	1776	1813	1848	1885	2050	2087	2123
	Soltis 86 / Acryl class 3 / Sergé	1530	1567	1764	1813	1848	1886	1923	1960	2168	2205	2242
1,20m-90°	Sergé 1% / Soltis 92	1592	1630	1836	1886	1926	1964	2003	2040	2258	2296	2336
	No fabric	1294	1334	1374	1424	1465	1503	1542	1581	1637	1675	1714
	Acryl class 1 & class 2	1527	1566	1735	1784	1822	1859	1897	1934	2116	2155	2190
1,40m-90°	Soltis 86 / Acryl class 3 / Sergé	1566	1603	1826	1875	1913	1950	1986	2024	2258	2293	2330
	Sergé 1% / Soltis 92	1629	1669	1901	1952	1991	2030	2067	2108	2351	2389	2427
	No fabric	1304	1343	1381	1436	1470	1514	1552	1591	1643	1683	1722
inclination 135°	Acryl class 1 & class 2	1589	1625	1817	1863	1902	1939	1977	2012	2216	2255	2291
	Soltis 86 / Acryl class 3	1633	1670	1922	1970	2008	2044	2081	2116	2378	2414	2451
	Soltis 92	1701	1739	2001	2051	2091	2130	2168	2205	2477	2515	2554
0,80m-135°	No fabric	1346	1385	1424	1477	1519	1558	1596	1636	1687	1726	1766
	Acryl class 1 & class 2	1499	1537	1691	1740	1779	1817	1852	1888	2060	2094	2133
	Soltis 86 / Acryl class 3 / Sergé	1532	1568	1772	1819	1857	1894	1930	1966	2181	2217	2255
1,00m-135°	Sergé 1% / Soltis 92	1594	1632	1843	1894	1932	1971	2009	2048	2271	2307	2347
	No fabric	1287	1327	1365	1418	1456	1495	1536	1573	1627	1666	1707
	Acryl class 1 & class 2	1535	1569	1752	1799	1836	1875	1910	1950	2141	2180	2215
1,20m-135°	Soltis 86 / Acryl class 3 / Sergé	1575	1611	1848	1899	1935	1971	2008	2045	2295	2330	2367
	Sergé 1% / Soltis 92	1642	1677	1926	1976	2014	2052	2091	2130	2391	2427	2467
	No fabric	1294	1334	1374	1424	1465	1503	1542	1581	1637	1675	1714
1,40m-135°	Acryl class 1 & class 2	1567	1604	1809	1859	1897	1932	1971	2007	2223	2261	2300
	Soltis 86 / Acryl class 3 / Sergé	1620	1655	1929	1977	2012	2050	2086	2121	2408	2445	2480
	Sergé 1% / Soltis 92	1685	1722	2008	2057	2095	2136	2173	2212	2507	2547	2585
Motor	No fabric	1304	1343	1381	1436	1470	1514	1552	1591	1643	1683	1722
	Acryl class 1 & class 2	1633	1670	1900	1952	1988	2026	2064	2100	2345	2383	2420
	Soltis 86 / Acryl class 3	1696	1733	2040	2087	2123	2161	2198	2233	2554	2591	2628
Valance	Soltis 92	1766	1804	2123	2174	2212	2250	2291	2325	2661	2699	2738
	No fabric	1346	1385	1424	1477	1519	1558	1596	1636	1687	1726	1766
	Sunea io + Sitio 1 io	included										
Orea WT + switch	Orea WT + switch	-29	-29	-29	-29	-29	-29	-29	-29	-29	-29	-29
	Straight valance	50	50	56	56	56	75	75	75	82	82	82
	Waved valance	60	60	71	71	71	93	93	93	103	103	103
Lacq	188	198	203	210	216	225	236	241	247	258	263	

⊕ Additional set-up cost of £298, Independently from dimensions or quantities. Trade Price March 2026 exc VAT.

Screens overview

ZIP Screen

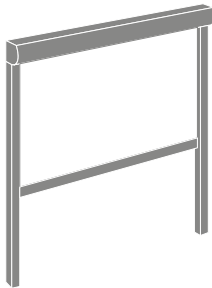

ZIP Screen Solar

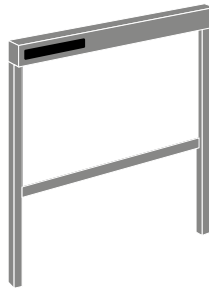

Built-in screen

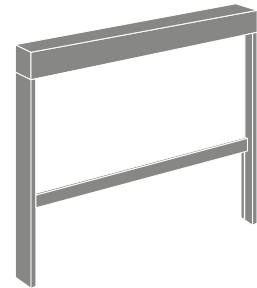

Indoor Screen

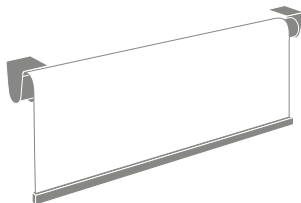

Corner Screen

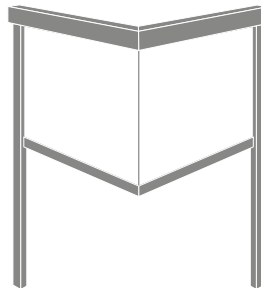

Options

Spacing profiles with initial order

Spacing profiles ordered separately (min 10 pieces of 3m)



Motor + transmitter
Sensors



Motor + transmitter
Sensors



Motor + switch

Choice of fabrics

Table	Soltis 86, Soltis 92, Screenfabric (fiberglass fabric 550g/m ²)	
£7/m	Sergé 600 Blockout LUNAR, Veozip surcharge instead of Soltis 86	£41m²
	Fabric confection and screens	87
	With standard or optional "anti-wrinkle" profile in flexible PVC (not for B1350 and B1200)	Table
Table	Price 2 windows in coupled screens = 2 x price window in single screen	Table
81		A

A	Height transparent window	1,21m	≤ 1,21m
	Height window from the ground	0,90m	≠ 0,90m
	Width screen till 3,00m	£142 net	£284net
	Width screen from 3,01m to 4,00m	£191 net	£380 net
	Width screen from 4,01m to 6,00m	£332 net	£567 net

No warranty on wrinkling and scratches

Table

Colours

Standard Colours

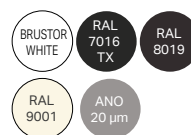

Other RAL-colours see table



Set-up cost:
£298 (<3 screens),
£150 (<5 screens),
free (≥5 screens)











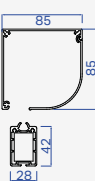
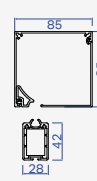

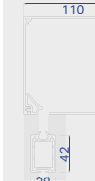
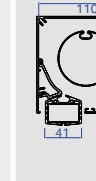

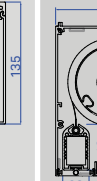
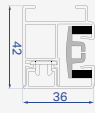
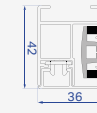
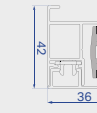
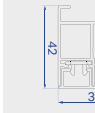





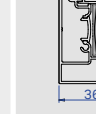







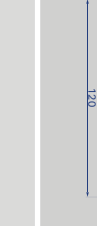

Special finish **90**

90

Brustor Preferred List

91

ZIP Screens profiles overview

	B1085 SR ZIP	B1085 C ZIP	B1100 SR ZIP	B1100 C ZIP	B1100 ZIP PRESTIGE	B1350 ZIP	B1200 ZIP
							
Dimensions	Width Simple: max 3,6m Coupled: max 7,2m Height max 1,8m	Width Simple: max 3,6m Coupled: max 7,2m Height max 1,8m	Width Simple: max 4,0m Coupled: max 7,2m Height max 3,5m	Width Simple: max 4,0m Coupled: max 7,2m Height max 3,5m	Width max 3,5m Height max 3,5m	Width max 6,0m Height max 6,0m Surface max 18m ²	Width max 5,0m Height max 3,5m Surface max 12m
ZIP Clips					⊗		
ZIP Screw	Optional 	Optional 	Optional 	Optional 		Optional 	Optional 
ZIP Couples rail					⊗	⊗	
ZIP Wide	⊗	⊗	⊗	⊗	⊗	⊗	
Optional spacing profile in combination with ZIP Clips					⊗		⊗
Optional spacing profile in combination with ZIP Screw							⊗
Solar	⊗	⊗	⊗	✓	✓	✓	⊗

Scale 1/100
In metres
width horizontal
height vertical

ZIP Screens

Application limits

Width →
Height ↓
B1085 ZIP, B1100 ZIP & B1100 ZIP Prestige Screen: max dimensions and application limits

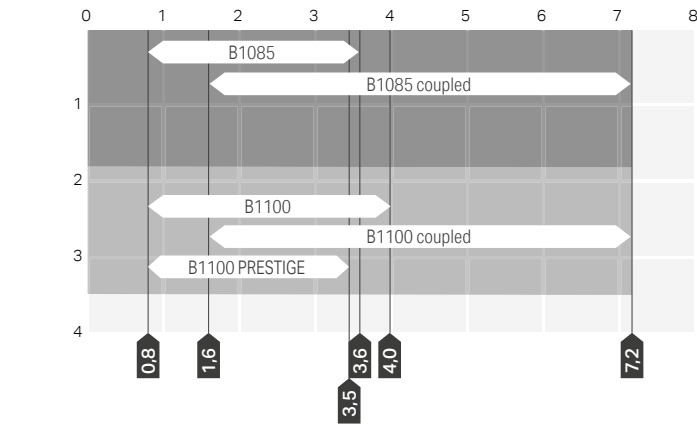

B1350 C ZIP Screen: max dimensions and application limits

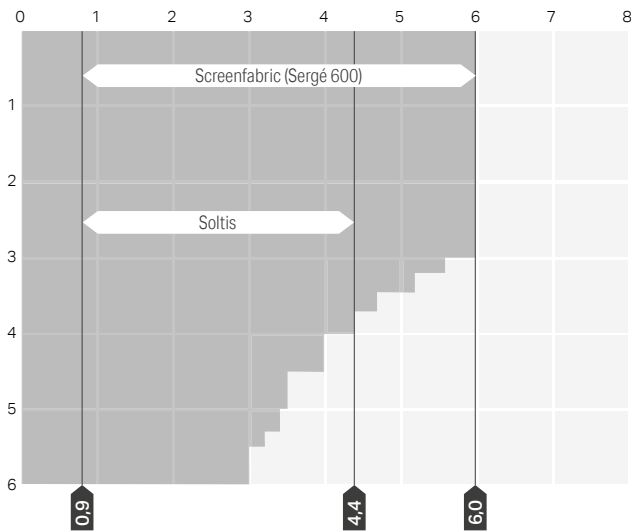

B1200 ZIP Screen: max dimensions and application limits

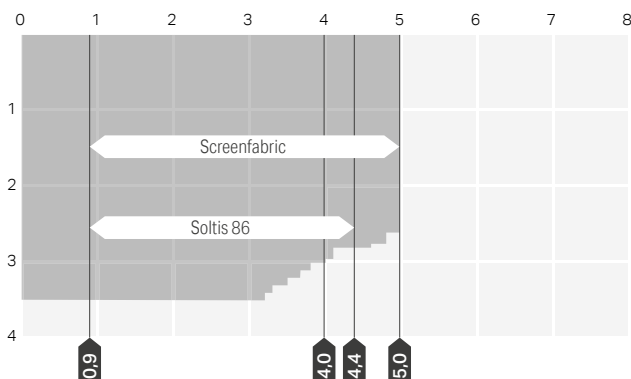

Minimum width for screens in function of chosen motor

Motor type	Minimum width
Sunilus io	0,80 m
Sunea io	0,76 m*
Sunea io LS40	0,64 m*
Maestria io	0,76 m*
Altus WT	0,81 m
Orea WT	0,90 m
Maestria WT	0,76 m*
RS100 Solar io	0,60 m*
Dooya	0,90 m
LT	0,70 m*
LT LS40	0,60 m*

* ZIP screens narrower than 0.80 m are without guarantee

B1085 ZIP

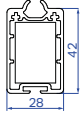
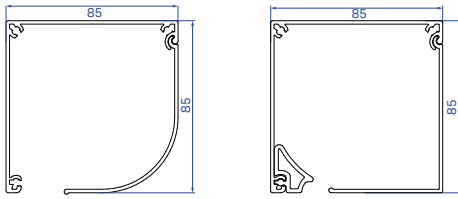

B1085 SR

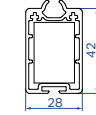

B1085 C

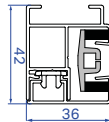

ZIP Clips rail
Standard

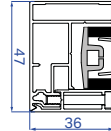

ZIP Screw Side rail
Option without
surcharge

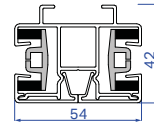

ZIP Coupled rail

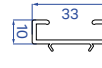

Spacing profile
ZIP Clips

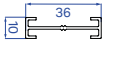

Spacing profile
ZIP Screw

Standard aluminum tubes & L-profiles available, list of types and prices in the standard colours, overview on page 94

Colours

Standard Colours

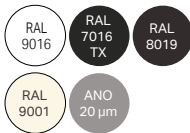

Other RAL-Colours



Set-up cost:
£298 (<3 screens),
£150 (<5 screens),
free (≥5 screens)

Bruster Preferred List
 **91**

Special finish 

 **90**

Options

1 Operation  **81**







2 Sensors  **81**



Choice between black or grey ZIP-rail **New**

Sergé 600 Blockout LUNAR/SOLAR surcharge instead of Sergé 600

Included

£41 / m²

		Width	Height (m)													Surcharge spacing profile
			0,60 - 1,00 	1,01 - 1,20	1,21 - 1,40	1,41 - 1,60	1,61 - 1,80	1,81 - 2,00	2,01 - 2,20	2,21 - 2,40	2,41 - 2,60	2,61 - 2,80	2,81 - 3,00	3,01 - 3,20	3,21 - 3,40	
		B1085 ZIP + Sunilus io + Situio 1 io														
0,75 - 0,50	Sergé 600 / Soltis 86 / Veozip	949	971	996	1022	1047	1069	1094	1117	1142	1167	1192	1331	1360	1391	23
	Sergé 1% / Soltis 92	985	1008	1036	1061	1085	1110	1136	1162	1186	1212	1238	1384	1414	1445	23
	Lacq + £298 	40	44	48	51	54	58	62	66	69	72	76	79	82	87	
1,00 - 0,76	Sergé 600 / Soltis 86 / Veozip	980	1004	1031	1058	1084	1111	1136	1164	1189	1217	1238	1386	1418	1452	27
	Sergé 1% / Soltis 92	1017	1043	1070	1099	1126	1155	1181	1209	1236	1266	1287	1440	1473	1507	27
	Lacq + £298 	42	46	50	53	57	60	65	68	71	75	77	81	86	89	
1,25 - 1,01	Sergé 600 / Soltis 86 / Veozip	1012	1040	1066	1096	1125	1152	1182	1209	1237	1268	1289	1440	1474	1509	32
	Sergé 1% / Soltis 92	1050	1078	1108	1137	1168	1196	1228	1255	1286	1317	1305	1496	1531	1569	32
	Lacq + £298 	45	48	52	56	59	62	67	70	74	77	80	84	88	92	
1,50 - 1,26	Sergé 600 / Soltis 86 / Veozip	1042	1071	1102	1132	1164	1194	1224	1254	1286	1316	1424	1495	1531	1568	38
	Sergé 1% / Soltis 92	1080	1112	1146	1178	1209	1241	1272	1305	1337	1369	1470	1554	1592	1631	38
	Lacq + £298 	47	50	54	58	61	65	69	72	76	79	82	87	90	94	
1,80 - 1,51	Sergé 600 / Soltis 86 / Veozip	1078	1111	1142	1179	1212	1243	1276	1309	1343	1377	1515	1559	1600	1640	41
	Sergé 1% / Soltis 92	1121	1155	1186	1225	1260	1292	1327	1361	1397	1432	1561	1622	1665	1707	41
	Lacq + £298 	49	52	57	60	63	67	71	75	78	81	84	89	93	96	
Motor	Sunilus io + Situio 1 io	included														
	Maestria io + Situio 1 io	73	73	73	73	73	73	73	73	73	73	73	73	73	73	
	Altus WT motor + switch	-20	-20	-20	-20	-20	-20	-20	-20	-20	-20	-20	-20	-20	-20	-20

 < 3 screens: Additional set-up cost of **£298** / < 5 screens: Additional set-up cost of **£150** / ≥ 5: **no set-up cost**  0,60 - 0,79m available without warranty  The minimum width is also determined by the selected motor, see p. 54. Trade Price March 2026 exc VAT.

B1085 ZIP Coupled

- B1085 SR: rounded and compact box of 85 x 85mm.
 - B1085 C: square box of 85 x 85mm.
 - Standard with Sunilus io + Situo 1 io
 - Standard with ZIP Clips or ZIP Screw rails.
 - Min Width screen: 0,8m (coupled: 1,6m)
 - Max Width screen: 3,6m (coupled: 7,2m)
 - Max Height screen: 1,8m
- Standard with roller tube \varnothing 63mm diameter and PVC "anti-wrinkle" profile to prevent visible markings on the screen fabric.
 - Coupled ZIP screen in 3 parts is not possible.
- ⚠ The minimum ratio of a coupled screen should be at least 1/3 - 2/3, i.e. the shortest part should be at least 1/3 of the total width.

		Width [ⓐ]														Surcharge spacing profile
		1,61 - 2,00	2,01 - 2,40	2,41 - 2,80	2,81 - 3,20	3,21 - 3,60	3,61 - 4,00	4,01 - 4,40	4,41 - 4,80	4,81 - 5,20	5,21 - 5,60	5,61 - 6,00	6,01 - 6,40	6,41 - 6,80	6,81 - 7,20	
Height (m)		B1085 ZIP coupled + Sunilus io + Situo 1 io														
0,75 - 0,50	Sergé 600 / Soltis 86 / Veozip	1284	1334	1383	1431	1480	1527	1603	1653	1700	1749	1797	1846	1897	1943	33
	Sergé 1% / Soltis 92	1336	1388	1437	1488	1539	1589	1668	1720	1770	1819	1872	1921	1973	2023	33
	Lacc [ⓐ] + £298 [ⓑ]	47	53	61	68	76	82	90	97	104	112	119	125	133	140	
1,00 - 0,76	Sergé 600 / Soltis 86 / Veozip	1331	1384	1437	1488	1542	1595	1673	1728	1778	1833	1884	1938	1991	2044	44
	Sergé 1% / Soltis 92	1383	1438	1494	1548	1604	1661	1741	1797	1850	1906	1961	2016	2072	2126	44
	Lacc [ⓐ] + £298 [ⓑ]	50	57	65	71	79	86	94	100	108	115	121	130	136	143	
1,25 - 1,01	Sergé 600 / Soltis 86 / Veozip	1378	1433	1489	1546	1603	1662	1743	1799	1857	1914	1971	2028	2085	2140	50
	Sergé 1% / Soltis 92	1433	1490	1549	1609	1668	1729	1815	1874	1935	1992	2053	2112	2171	2230	50
	Lacc [ⓐ] + £298 [ⓑ]	53	60	68	75	82	89	96	103	111	118	124	133	139	147	
1,50 - 1,26	Sergé 600 / Soltis 86 / Veozip	1425	1486	1545	1604	1667	1728	1814	1875	1937	1998	2058	2118	2179	2241	57
	Sergé 1% / Soltis 92	1483	1546	1607	1669	1734	1797	1887	1951	2015	2079	2141	2205	2270	2334	57
	Lacc [ⓐ] + £298 [ⓑ]	57	63	71	78	84	93	99	107	114	121	129	136	142	151	
1,80 - 1,51	Sergé 600 / Soltis 86 / Veozip	1484	1547	1613	1675	1740	1806	1900	1965	2032	2097	2161	2228	2295	2360	66
	Sergé 1% / Soltis 92	1544	1610	1677	1743	1810	1880	1977	2047	2115	2181	2251	2320	2389	2457	66
	Lacc [ⓐ] + £298 [ⓑ]	60	67	74	81	88	96	102	111	117	124	132	139	146	153	
Motor	Sunilus io + Situo 1 io	included														
	Maestria io + Situo 1 io	73	73	73	73	73	73	73	73	73	73	73	73	73	73	73
	Altus WT motor + switch	-20	-20	-20	-20	-20	-20	-20	-20	-20	-20	-20	-20	-20	-20	-20

[ⓐ] < 3 screens: Additional set-up cost of £298 / < 5 screens: Additional set-up cost of £150 / ≥ 5: no set-up cost [ⓑ] The minimum ratio of a coupled screen should be at least 1/3 - 2/3, i.e. the shortest part should be at least 1/3 of the total width. Trade Price March 2026 exc VAT.

B1100 ZIP

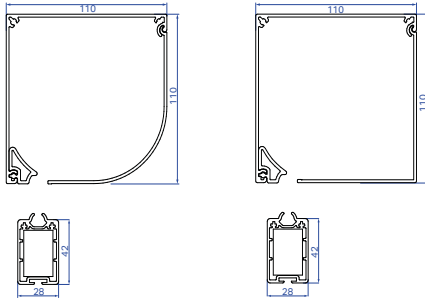

B1100 SR

B1100 C

Standard aluminum tubes & L-profiles available, list of types and prices in the standard colours, overview on page 94

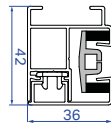

ZIP Clips rail
Standard

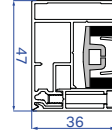

ZIP Screw Side rail
Option without
surcharge

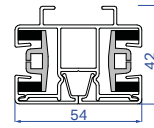

ZIP Coupled rail

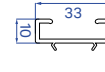

Spacing profile
ZIP Clips

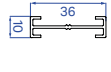

Spacing profile
ZIP Screw

Colours

Standard Colours

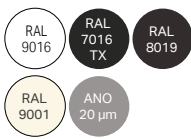

Other RAL-Colours



Set-up cost:
£298 (<3 screens),
£150 (<5 screens),
free (≥5 screens)

Bruster Preferred List
91

Special finish



Options

- 1 Operation
- 2 Sensors

81

81

Choice between black or grey ZIP-rail **New**
Sergé 600 Blockout LUNAR/SOLAR surcharge instead of Sergé 600

Included
£41 / m²

Height (m)	Width	B1100 ZIP + Sunilus io + Situio 1 io																Surcharge spacing profile
		0,60 - 1,00	1,01 - 1,20	1,21 - 1,40	1,41 - 1,60	1,61 - 1,80	1,81 - 2,00	2,01 - 2,20	2,21 - 2,40	2,41 - 2,60	2,61 - 2,80	2,81 - 3,00	3,01 - 3,20	3,21 - 3,40	3,41 - 3,60	3,61 - 3,80	3,81 - 4,00	
0,75 - 0,90	Sergé 600 / Soltis 86 / Veozip	865	892	918	945	970	997	1024	1050	1075	1101	1128	1155	1181	1206	1233	1258	18
	Sergé 1% / Soltis 92	898	927	954	982	1007	1037	1063	1090	1117	1143	1171	1199	1226	1253	1281	1308	18
	Lacq + £298	26	29	33	36	40	44	48	51	54	58	62	66	69	72	76	80	
1,00 - 1,06	Sergé 600 / Soltis 86 / Veozip	892	919	949	976	1004	1032	1060	1088	1117	1146	1172	1202	1230	1258	1287	1315	23
	Sergé 1% / Soltis 92	927	955	985	1014	1043	1071	1101	1131	1162	1190	1220	1248	1278	1308	1338	1367	23
	Lacq + £298	28	31	35	39	42	46	50	53	57	60	65	68	71	75	78	82	
1,25 - 1,01	Sergé 600 / Soltis 86 / Veozip	917	948	977	1006	1038	1067	1099	1128	1160	1188	1220	1250	1280	1309	1340	1372	27
	Sergé 1% / Soltis 92	953	984	1015	1045	1077	1109	1140	1171	1205	1235	1268	1298	1332	1361	1394	1424	27
	Lacq + £298	30	33	38	41	45	48	52	56	59	62	67	70	74	77	80	84	
1,50 - 1,26	Sergé 600 / Soltis 86 / Veozip	944	976	1006	1040	1070	1103	1134	1168	1200	1232	1267	1292	1330	1361	1395	1425	30
	Sergé 1% / Soltis 92	981	1014	1045	1078	1111	1147	1180	1214	1247	1280	1316	1344	1382	1415	1449	1483	30
	Lacq + £298	32	36	40	44	47	50	54	58	61	65	69	72	76	79	82	87	
1,75 - 1,51	Sergé 600 / Soltis 86 / Veozip	969	1003	1037	1070	1103	1137	1172	1207	1242	1276	1310	1344	1380	1413	1448	1483	34
	Sergé 1% / Soltis 92	1006	1042	1076	1111	1147	1182	1220	1254	1291	1327	1362	1398	1434	1468	1506	1543	34
	Lacq + £298	34	39	42	46	49	52	57	60	63	67	71	75	78	81	86	89	
2,00 - 1,76	Sergé 600 / Soltis 86 / Veozip	996	1031	1066	1102	1137	1172	1210	1247	1283	1319	1356	1392	1427	1465	1501	1538	41
	Sergé 1% / Soltis 92	1036	1070	1108	1146	1182	1220	1257	1296	1334	1374	1410	1447	1486	1523	1561	1600	41
	Lacq + £298	36	41	45	48	51	54	59	62	66	69	74	77	80	83	88	92	
2,25 - 2,01	Sergé 600 / Soltis 86 / Veozip	1023	1059	1098	1134	1171	1210	1248	1287	1326	1362	1402	1440	1477	1518	1557	1594	45
	Sergé 1% / Soltis 92	1062	1100	1139	1180	1218	1257	1297	1338	1378	1416	1458	1497	1538	1579	1619	1658	45
	Lacq + £298	39	44	47	50	53	57	61	65	68	71	76	79	82	86	90	94	
2,50 - 2,26	Sergé 600 / Soltis 86 / Veozip	1049	1088	1128	1167	1206	1247	1287	1327	1367	1406	1448	1488	1527	1567	1609	1650	49
	Sergé 1% / Soltis 92	1088	1131	1171	1212	1253	1296	1338	1379	1420	1462	1506	1548	1589	1631	1673	1717	49
	Lacq + £298	41	46	49	52	56	60	63	67	70	74	78	81	84	88	93	96	
2,75 - 2,51	Sergé 600 / Soltis 86 / Veozip	1074	1116	1160	1200	1241	1283	1326	1367	1409	1451	1494	1535	1579	1621	1665	1706	52
	Sergé 1% / Soltis 92	1115	1161	1205	1247	1290	1334	1378	1420	1463	1508	1553	1596	1642	1687	1731	1774	52
	Lacq + £298	44	48	51	54	58	62	66	69	72	76	80	83	87	90	95	98	
3,00 - 2,76	Sergé 600 / Soltis 86 / Veozip	1100	1144	1187	1232	1275	1319	1362	1406	1452	1495	1539	1584	1628	1672	1717	1761	56
	Sergé 1% / Soltis 92	1142	1189	1234	1280	1326	1374	1416	1462	1509	1554	1601	1649	1693	1739	1785	1833	56
	Lacq + £298	46	50	53	57	60	65	68	71	75	78	82	86	89	93	97	100	
3,25 - 3,01	Sergé 600 / Soltis 86 / Veozip	1131	1179	1225	1273	1319	1367	1413	1459	1507	1556	1601	1649	1696	1742	1791	1838	61
	Sergé 1% / Soltis 92	1175	1225	1274	1323	1374	1420	1468	1519	1567	1617	1666	1715	1763	1814	1863	1914	61
	Lacq + £298	48	52	56	59	62	67	70	74	77	80	84	88	92	95	99	102	
3,50 - 3,26	Sergé 600 / Soltis 86 / Veozip	1160	1206	1255	1306	1354	1402	1452	1501	1550	1599	1649	1697	1745	1795	1844	1895	65
	Sergé 1% / Soltis 92	1205	1253	1306	1356	1406	1459	1509	1561	1612	1664	1715	1764	1816	1869	1919	1972	65
	Lacq + £298	50	54	58	61	65	69	72	76	79	82	87	90	94	97	101	104	
Motor	Sunilus io + Situio 1 io	included																
	Maestria io + Situio 1 io	73	73	73	73	73	73	73	73	73	73	73	73	73	73	82	82	
	Altus WT motor + switch	-20	-20	-20	-20	-20	-20	-20	-20	-20	-20	-20	-20	-20	-20	-23	-23	

⊖ < 3 screens: Additional set-up cost of £298 / < 5 screens: Additional set-up cost of £150 / ≥ 5: no set-up cost ⊕ 0,60 - 0,79m available without warranty ⊕ The minimum width is also determined by the selected motor, see p. 54. Trade Price March 2026 exc VAT.

B1100 ZIP Coupled

- B1100 SR: compact half round box of 110 x 110mm.
- B1100 C: tight, square box of 110 x 110mm.
- Standard with Sunilus io + Situio 1 io.
- Standard with ZIP Clips or ZIP Screw rails.
- Standard with roller tube of \varnothing 78mm diameter and PVC "anti-wrinkle" profile to prevent visible markings on the screen fabric.

- Max width screen: 4,0m (coupled: 7,2m)
 - Min width screen: 0,8m (coupled: 1,6m)
 - Max height screen: 3,5m
 - Coupled ZIP screen not possible in 3 parts.
- △ The minimum ratio of a coupled screen should be at least 1/3 - 2/3, i.e. the shortest part should be at least 1/3 of the total width.

Long end brackets B1 100 R (cannot be coupled)

£42

		Width \varnothing														Surcharge spacing profile
		1,60 - 2,00	2,01 - 2,40	2,41 - 2,80	2,81 - 3,20	3,20 - 3,60	3,61 - 4,00	4,01 - 4,40	4,41 - 4,80	4,81 - 5,20	5,21 - 5,60	5,61 - 6,00	6,01 - 6,40	6,41 - 6,80	6,81 - 7,20	
Height (m)		B1100 ZIP coupled + Sunilus io + Situio 1 io														
0,75-0,50	Sergé 600 / Soltis 86 / Veozip	1311	1367	1421	1475	1530	1585	1668	1722	1776	1830	1884	1939	1994	2049	33
	Sergé 1% / Soltis 92	1363	1420	1480	1535	1593	1650	1735	1791	1847	1904	1961	2018	2075	2132	33
	Lacq $\text{C} + \text{£298}$ C	47	53	61	68	76	82	90	97	104	112	119	125	133	140	
1,00-0,76	Sergé 600 / Soltis 86 / Veozip	1359	1418	1475	1535	1594	1652	1737	1795	1854	1913	1970	2029	2088	2148	44
	Sergé 1% / Soltis 92	1412	1475	1535	1596	1658	1719	1806	1869	1930	1991	2051	2113	2173	2234	44
	Lacq $\text{C} + \text{£298}$ C	50	57	63	71	79	86	94	100	108	115	121	130	136	143	
1,25-1,01	Sergé 600 / Soltis 86 / Veozip	1404	1467	1529	1594	1655	1720	1808	1869	1934	1995	2058	2120	2181	2245	50
	Sergé 1% / Soltis 92	1461	1525	1592	1658	1722	1789	1881	1945	2012	2077	2141	2208	2272	2339	50
	Lacq $\text{C} + \text{£298}$ C	53	60	68	75	82	89	96	103	111	118	124	133	139	147	
1,50-1,26	Sergé 600 / Soltis 86 / Veozip	1455	1519	1585	1652	1717	1783	1878	1944	2011	2077	2144	2211	2278	2346	57
	Sergé 1% / Soltis 92	1514	1580	1650	1719	1785	1856	1955	2025	2094	2161	2232	2301	2372	2443	57
	Lacq $\text{C} + \text{£298}$ C	57	63	71	78	84	93	99	107	114	121	129	136	142	151	
1,75-1,51	Sergé 600 / Soltis 86 / Veozip	1503	1570	1641	1710	1779	1850	1949	2019	2093	2160	2232	2302	2375	2445	66
	Sergé 1% / Soltis 92	1563	1634	1708	1778	1851	1926	2028	2103	2176	2249	2324	2398	2471	2546	66
	Lacq $\text{C} + \text{£298}$ C	60	67	74	81	88	96	102	111	117	124	132	139	146	153	
2,00-1,76	Sergé 600 / Soltis 86 / Veozip	1550	1623	1697	1771	1844	1916	2018	2095	2169	2243	2319	2393	2468	2545	76
	Sergé 1% / Soltis 92	1612	1689	1764	1843	1919	1994	2102	2178	2259	2337	2413	2493	2571	2650	76
	Lacq $\text{C} + \text{£298}$ C	62	70	77	84	92	99	105	114	120	129	135	141	150	156	
2,25-2,01	Sergé 600 / Soltis 86 / Veozip	1599	1675	1754	1830	1907	1986	2091	2168	2245	2326	2406	2483	2564	2642	83
	Sergé 1% / Soltis 92	1664	1743	1824	1904	1987	2066	2175	2258	2339	2423	2504	2586	2671	2753	83
	Lacq $\text{C} + \text{£298}$ C	66	74	80	88	95	102	109	116	123	131	138	144	153	159	
2,50-2,26	Sergé 600 / Soltis 86 / Veozip	1647	1728	1809	1890	1971	2053	2161	2243	2324	2409	2491	2575	2658	2742	94
	Sergé 1% / Soltis 92	1713	1797	1883	1967	2053	2137	2251	2337	2420	2509	2594	2682	2768	2854	94
	Lacq $\text{C} + \text{£298}$ C	69	77	83	92	98	104	113	119	126	134	141	149	156	162	
2,75-2,51	Sergé 600 / Soltis 86 / Veozip	1693	1779	1864	1951	2036	2121	2234	2320	2406	2491	2579	2665	2753	2840	100
	Sergé 1% / Soltis 92	1761	1851	1941	2030	2118	2210	2326	2414	2504	2594	2685	2778	2867	2958	100
	Lacq $\text{C} + \text{£298}$ C	72	79	87	94	101	109	116	122	131	137	144	152	159	166	
3,00-2,76	Sergé 600 / Soltis 86 / Veozip	1741	1831	1921	2010	2102	2191	2305	2396	2486	2575	2665	2756	2846	2940	111
	Sergé 1% / Soltis 92	1813	1905	2000	2093	2187	2282	2402	2495	2588	2682	2778	2871	2966	3062	111
	Lacq $\text{C} + \text{£298}$ C	76	82	90	97	104	112	119	125	134	140	149	155	161	170	
3,25-3,01	Sergé 600 / Soltis 86 / Veozip	1846	1940	2035	2129	2221	2317	2410	2504	2599	2692	2786	2879	2975	3071	118
	Sergé 1% / Soltis 92	1921	2019	2117	2216	2314	2411	2510	2609	2707	2803	2901	2999	3099	3198	118
	Lacq $\text{C} + \text{£298}$ C	79	86	94	100	108	115	122	130	136	143	151	158	165	173	
3,50-3,26	Sergé 600 / Soltis 86 / Veozip	1900	1998	2097	2193	2289	2388	2487	2585	2683	2781	2877	2976	3075	3173	124
	Sergé 1% / Soltis 92	1977	2079	2181	2284	2385	2486	2589	2693	2796	2895	2998	3100	3204	3306	124
	Lacq $\text{C} + \text{£298}$ C	82	89	97	103	112	118	124	133	139	147	154	161	168	176	
Motor	Sunilus io + Situio 1 io	included														
	Maestria io + Situio 1 io	73	73	73	73	73	73	73	73	73	73	73	73	73	73	73
	Altus WT motor + switch	-20	-20	-20	-20	-20	-20	-20	-20	-20	-20	-20	-20	-20	-20	-20

C < 3 screens: Additional set-up cost of £298 / < 5 screens: Additional set-up cost of £150 / \geq 5: no set-up cost C The minimum ratio of a coupled screen should be at least 1/3 - 2/3, i.e. the shortest part should be at least 1/3 of the total width. Trade Price March 2026 exc VAT.

B1100 ZIP Prestige

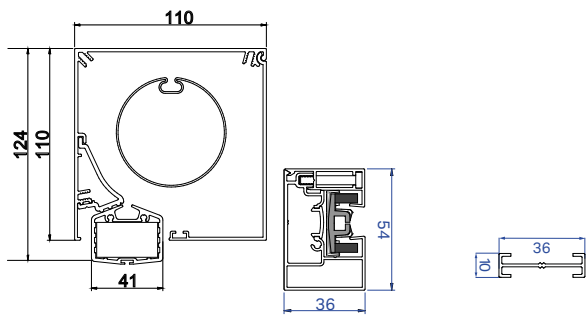

B1100 ZIP Prestige

ZIP Prestige Side rail

Spacing profile

Colours

Standard Colours



all RAL standard

Brustor Preferred List

91

Special finish

90

Options

1 Operation

81

2 Sensors

81

Choice between black or grey ZIP-rail **New**

Sergé 600 Blockout LUNAR/SOLAR surcharge instead of Sergé 600

Included

£41 / m²

Height (m)	Width	B1100 ZIP Prestige + Sunilus io + Situo 1 io													Surcharge spacing profile
		0,60 - 1,00 E	1,01 - 1,20	1,21 - 1,40	1,41 - 1,60	1,61 - 1,80	1,81 - 2,00	2,01 - 2,20	2,21 - 2,40	2,41 - 2,60	2,61 - 2,80	2,81 - 3,00	3,01 - 3,20	3,21 - 3,50	
0,75 - 0,50	Sergé 600 / Soltis 86 / Veozip	810	824	855	887	1020	1050	1077	1104	1131	1160	1188	1215	1243	19
	Sergé 1% / Soltis 92	845	860	893	924	1061	1091	1121	1148	1175	1203	1233	1262	1291	19
1,00 - 0,76	Sergé 600 / Soltis 86 / Veozip	868	884	918	953	1098	1129	1160	1190	1223	1253	1284	1314	1346	23
	Sergé 1% / Soltis 92	856	874	910	947	1091	1124	1158	1188	1221	1250	1284	1315	1348	23
1,25 - 1,01	Sergé 600 / Soltis 86 / Veozip	882	901	941	980	1128	1162	1195	1230	1262	1296	1333	1359	1399	27
	Sergé 1% / Soltis 92	921	942	982	1020	1170	1208	1242	1278	1313	1348	1385	1415	1455	27
1,50 - 1,26	Sergé 600 / Soltis 86 / Veozip	949	971	1014	1055	1208	1244	1284	1320	1358	1396	1433	1470	1509	32
	Sergé 1% / Soltis 92	934	958	1002	1044	1196	1234	1274	1313	1351	1389	1427	1465	1504	32
1,75 - 1,51	Sergé 600 / Soltis 86 / Veozip	960	987	1033	1077	1233	1274	1314	1354	1395	1433	1476	1517	1556	34
	Sergé 1% / Soltis 92	1002	1029	1076	1124	1283	1322	1365	1406	1451	1491	1536	1575	1617	34
2,00 1,76	Sergé 600 / Soltis 86 / Veozip	1027	1061	1108	1159	1319	1364	1406	1452	1496	1539	1585	1630	1671	41
	Sergé 1% / Soltis 92	1012	1042	1092	1143	1307	1351	1395	1438	1483	1527	1572	1616	1663	41
2,25 - 2,01	Sergé 600 / Soltis 86 / Veozip	1038	1071	1124	1175	1342	1389	1433	1481	1529	1573	1619	1668	1714	46
	Sergé 1% / Soltis 92	1081	1121	1173	1228	1395	1445	1491	1539	1589	1636	1685	1736	1781	46
2,50 - 2,26	Sergé 600 / Soltis 86 / Veozip	1111	1148	1206	1260	1445	1496	1545	1599	1649	1703	1753	1806	1856	50
	Sergé 1% / Soltis 92	1090	1128	1184	1241	1425	1477	1529	1580	1632	1683	1736	1787	1835	50
2,75 - 2,51	Sergé 600 / Soltis 86 / Veozip	1130	1174	1221	1262	1307	1351	1395	1438	1483	1527	1572	1616	1663	53
	Sergé 1% / Soltis 92	1173	1222	1269	1313	1358	1403	1451	1496	1542	1589	1635	1680	1728	53
3,00 - 2,76	Sergé 600 / Soltis 86 / Veozip	1159	1204	1249	1296	1342	1389	1433	1481	1529	1573	1619	1668	1714	56
	Sergé 1% / Soltis 92	1203	1252	1298	1348	1395	1445	1491	1539	1589	1636	1685	1736	1781	56
3,25 - 3,01	Sergé 600 / Soltis 86 / Veozip	1190	1241	1289	1340	1389	1438	1487	1537	1586	1637	1685	1736	1783	62
	Sergé 1% / Soltis 92	1239	1289	1341	1393	1445	1496	1545	1599	1649	1703	1753	1806	1856	62
3,50 - 3,26	Sergé 600 / Soltis 86 / Veozip	1221	1270	1321	1374	1425	1477	1529	1580	1632	1683	1736	1787	1835	65
	Sergé 1% / Soltis 92	1269	1319	1374	1427	1481	1537	1589	1643	1697	1751	1806	1858	1913	65
Motor	Sunilus io + Situo 1 io	included													
	Maestria io + Situo 1 io	66	66	66	66	66	66	66	66	66	66	66	66	66	66
	Altus WT motor + switch	-34	-34	-34	-34	-34	-34	-34	-34	-34	-34	-34	-34	-34	-34

E 0,60 - 0,79m available without warranty **F** The minimum width is also determined by the selected motor, see p. 54
Trade Price March 2026 exc VAT.

- B1100 Prestige: tight, square box of 110 x 110mm.
- Lead rail partially disappears into the housing
(Total height including bottom rail = 124 mm)
- Standard with Sunilus io + Situo 1 io.
- Standard with ZIP Screw rails (36 x 54mm)
- Standard with roller tube \varnothing 63mm diameter and PVC "anti-wrinkle" profile to prevent visible markings on the screen fabric
- Easy disassembly of the roller tube
- Max width screen: 3,5m
- Min width screen: 0,8m
- Max height screen: 3,5m

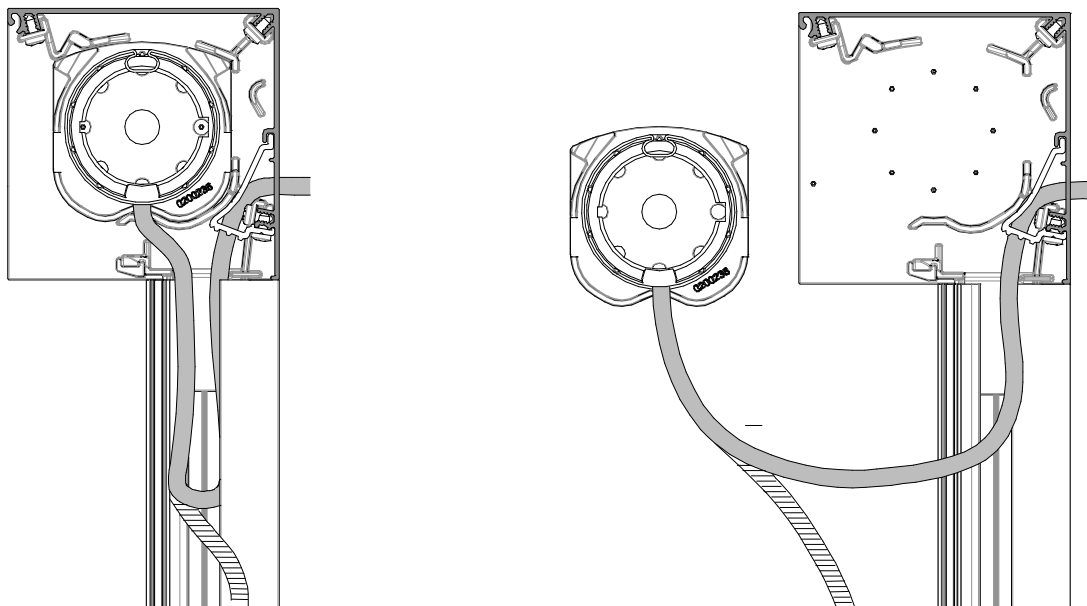

B1350 ZIP

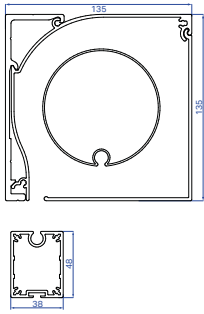

B1350

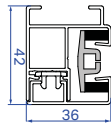

ZIP Clips rail
Standard

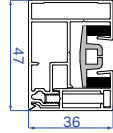

ZIP Screw Side rail
Option without
surcharge

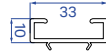

Spacing profile
ZIP Clips

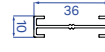

Spacing profile
ZIP Screw

Standard aluminum tubes & L-profiles available, list of types and prices in the standard colours, overview on page 94

Colours

Standard Colours

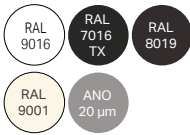

Other RAL-Colours



Set-up cost:
£298 (<3 screens),
£150 (<5 screens),
free (≥5 screens)

Bruster Preferred List
91

Special finish



Options

- 1 Operation
- 2 Sensors

81

81

Choice between black or grey ZIP-rail **New**
Sergé 600 Blockout LUNAR/SOLAR surcharge instead of Sergé 600

Included
£41/m²

Position of the adapters

Height (m)	Width	B1350 C ZIP + Sunea io + Situo 1 io (of Maestria io + Situo 1 io)													Surcharge spacing profile
		0,90 - 1,00 F	1,01 - 1,20	1,21 - 1,40	1,41 - 1,60	1,61 - 1,80	1,81 - 2,00	2,01 - 2,20	2,21 - 2,40	2,41 - 2,60	2,61 - 2,80	2,81 - 3,00	3,01 - 3,20	3,21 - 3,40	
0,75 - 0,50	Sergé 600 / Soltis 86 / Veozip	1058	1133	1121	1151	1184	1214	1245	1275	1311	1340	1372	1402	1433	18
	Sergé 1% / Soltis 92	1101	1179	1209	1243	1275	1308	1339	1372	1364	1395	1426	1461	1491	18
	Lacq C + £298 F	70	74	78	81	84	88	92	95	54	58	62	66	69	
1,00 - 0,76	Sergé 600 / Soltis 86 / Veozip	1126	1159	1192	1225	1258	1292	1325	1356	1351	1383	1416	1446	1480	23
	Sergé 1% / Soltis 92	1169	1203	1238	1272	1308	1342	1377	1410	1449	1483	1519	1549	1584	67
	Lacq C + £298 F	72	76	80	83	87	90	94	97	101	104	109	113	116	
1,25 - 1,01	Sergé 600 / Soltis 86 / Veozip	1148	1183	1216	1252	1289	1322	1359	1395	1433	1468	1504	1539	1574	71
	Sergé 1% / Soltis 92	1193	1229	1265	1301	1339	1374	1412	1449	1489	1526	1564	1599	1636	71
	Lacq C + £298 F	75	78	82	86	89	92	96	100	103	107	112	115	118	
1,50 - 1,26	Sergé 600 / Soltis 86 / Veozip	1171	1207	1243	1279	1317	1355	1395	1431	1472	1508	1546	1583	1620	75
	Sergé 1% / Soltis 92	1215	1254	1292	1329	1369	1409	1449	1486	1529	1568	1608	1647	1685	75
	Lacq C + £298 F	77	81	84	88	91	94	98	102	105	109	114	117	120	
1,75 - 1,51	Sergé 600 / Soltis 86 / Veozip	1194	1233	1271	1309	1349	1388	1427	1467	1511	1549	1589	1630	1670	79
	Sergé 1% / Soltis 92	1241	1280	1320	1360	1401	1441	1484	1525	1570	1612	1652	1694	1737	79
	Lacq C + £298 F	79	83	87	90	93	96	101	104	108	112	116	119	122	
2,00 - 1,76	Sergé 600 / Soltis 86 / Veozip	1216	1258	1298	1339	1379	1418	1462	1504	1548	1590	1633	1675	1715	86
	Sergé 1% / Soltis 92	1265	1308	1350	1392	1433	1475	1521	1564	1611	1653	1698	1742	1783	86
	Lacq C + £298 F	81	86	89	92	95	98	103	107	111	114	118	121	124	
2,25 - 2,01	Sergé 600 / Soltis 86 / Veozip	1239	1281	1326	1369	1411	1454	1498	1541	1588	1633	1676	1720	1762	89
	Sergé 1% / Soltis 92	1288	1332	1378	1421	1466	1510	1558	1601	1651	1698	1743	1788	1835	89
	Lacq C + £298 F	83	88	91	94	97	101	105	109	113	116	120	123	126	
2,50 - 2,26	Sergé 600 / Soltis 86 / Veozip	1264	1307	1352	1399	1442	1486	1532	1578	1629	1674	1720	1764	1811	93
	Sergé 1% / Soltis 92	1312	1357	1404	1453	1499	1544	1594	1640	1693	1741	1788	1836	1883	93
	Lacq C + £298 F	86	90	93	96	100	104	108	112	115	118	122	125	129	
2,75 - 2,51	Sergé 600 / Soltis 86 / Veozip	1287	1333	1379	1426	1474	1521	1569	1615	1668	1714	1760	1811	1858	96
	Sergé 1% / Soltis 92	1337	1384	1433	1483	1532	1581	1632	1679	1735	1782	1833	1883	1934	96
	Lacq C + £298 F	88	92	95	98	102	107	111	114	117	120	124	128	131	
Motor	Sunea io + Situo 1 io									included					
	Maestria io + Situo 1 io									included					
	Orea WT motor + switch	-46	-46	-46	-46	-46	-46	-46	-46	-46	-46	-46	-46	-46	

C < 3 screens: Additional set-up cost of £298 / < 5 screens: Additional set-up cost of £150 / ≥ 5: no set-up cost **F** The minimum width is also determined by the selected motor, see p. 54

Trade Price March 2026 exc VAT.

B1350 ZIP

- B1350 C: tight, square box of 135 x 135mm.
- Standard with Sunea io + Situio 1 io.
- Standard with ZIP Clips rails (Optional ZIP screw without surcharge)
- Max dimensions Screen: 18m² surface / 6m width / 6m high
- Max dimensions Soltis: 18m² surface / 4,4m width / 4,5m high
- Min width screen: 0,8m.
- Standard with roller tube of $\varnothing 85$ mm diameter / $\varnothing 100$ mm bij >4,5m and PVC "anti-wrinkle" profile to prevent visible markings on the screen fabric.
- Mounting of the box always by means of adapters **A**
- Cannot be coupled

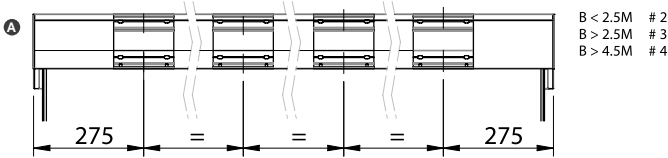

		Width														Surcharge spacing profile
		3,41 - 3,60	3,61 - 3,80	3,81 - 4,00	4,01 - 4,20	4,21 - 4,40	4,41 - 4,60 B	4,61 - 4,80 B	4,81 - 5,00 B	5,01 - 5,20 B	5,21 - 5,40 B	5,41 - 5,60 B	5,61 - 5,80 B	5,81 - 6,00 B		
Height (m)		B1350 C ZIP + Sunea io + Situio 1 io (of Maestria io + Situio 1 io)														
0,75 - 0,90	Sergé 600 / Soltis 86 / Veozip	1470	1502	1533	1564	1594	1630	1661	1692	1721	1753	1785	1817	1846	19	
	Sergé 1% / Soltis 92	1530	1562	1596	1629	1658									19	
	Lacq ⊕ + £298 Ⓜ	72	77	81	84	88	91	95	98	101	105	109	114	116		
1,00 - 0,76	Sergé 600 / Soltis 86 / Veozip	1520	1551	1586	1617	1652	1690	1722	1756	1790	1823	1857	1888	1922	23	
	Sergé 1% / Soltis 92	1582	1615	1651	1686	1718									23	
	Lacq ⊕ + £298 Ⓜ	75	78	83	86	90	93	97	101	103	108	112	116	119		
1,25 - 1,01	Sergé 600 / Soltis 86 / Veozip	1571	1605	1641	1677	1711	1752	1787	1822	1857	1892	1928	1964	1999	27	
	Sergé 1% / Soltis 92	1636	1672	1710	1747	1781									27	
	Lacq ⊕ + £298 Ⓜ	78	81	86	89	92	95	100	102	107	109	115	117	121		
1,50 - 1,26	Sergé 600 / Soltis 86 / Veozip	1620	1656	1694	1733	1769	1811	1851	1886	1923	1963	2000	2036	2075	32	
	Sergé 1% / Soltis 92	1687	1725	1764	1803	1841									32	
	Lacq ⊕ + £298 Ⓜ	79	83	88	91	94	97	101	105	109	112	116	120	123		
1,75 - 1,51	Sergé 600 / Soltis 86 / Veozip	1669	1708	1747	1787	1825	1871	1910	1948	1988	2028	2068	2107	2147	34	
	Sergé 1% / Soltis 92	1741	1780	1822	1862	1903									34	
	Lacq ⊕ + £298 Ⓜ	82	86	90	93	96	100	103	108	110	115	119	122	125		
2,00 - 1,76	Sergé 600 / Soltis 86 / Veozip	1718	1762	1803	1844	1886	1935	1974	2018	2057	2102	2141	2184	2225	41	
	Sergé 1% / Soltis 92	1790	1835	1879	1922	1966									41	
	Lacq ⊕ + £298 Ⓜ	84	89	92	95	98	101	107	109	114	116	121	124	128		
2,25 - 2,01	Sergé 600 / Soltis 86 / Veozip	1769	1816	1857	1903	1944	1993	2039	2082	2126	2170	2213	2257	2303	46	
	Sergé 1% / Soltis 92	1841	1888	1934	1981	2026									46	
	Lacq ⊕ + £298 Ⓜ	86	91	94	97	101	103	109	112	116	119	123	126	130		
2,50 - 2,26	Sergé 600 / Soltis 86 / Veozip	1821	1866	1913	1957	2004	2055	2102	2147	2193	2238	2284	2331	2378	50	
	Sergé 1% / Soltis 92	1895	1943	1992	2040	2088									50	
	Lacq ⊕ + £298 Ⓜ	89	93	96	100	102	107	110	115	117	121	125	129	132		
2,75 - 2,51	Sergé 600 / Soltis 86 / Veozip	1872	1918	1967	2013	2062	2115	2163	2212	2259	2309	2357	2403	2452	53	
	Sergé 1% / Soltis 92	1947	1999	2048	2097	2149									53	
	Lacq ⊕ + £298 Ⓜ	91	95	98	101	105	109	114	116	120	123	128	132	134		
Motor	Sunea io + Situio 1 io	included														
	Maestria io + Situio 1 io	included														
	Orea WT + switch	-86	-86	-86	-86	-86	-86	-86	-86	-86	-86	-86	-86	-86	-86	

Ⓜ Not possible as Soltis 86 (max 4,40m) **⊕** < 3 screens: Additional set-up cost of **£298** / < 5 screens: Additional set-up cost of **£150** / ≥ 5: **no set-up cost**
 Trade Price March 2026 exc VAT.

B1350 ZIP

		Width													Surcharge spacing profile
		0,90 - 1,00 [Ⓢ]	1,01 - 1,20	1,21 - 1,40	1,41 - 1,60	1,61 - 1,80	1,81 - 2,00	2,01 - 2,20	2,21 - 2,40	2,41 - 2,60	2,61 - 2,80	2,81 - 3,00	3,01 - 3,20	3,21 - 3,40	
Height (m)		B1350 C ZIP + Sunea io + Situio 1 io (of Maestria io + Situio 1 io)													
3,00 - 2,76	Sergé 600 / Soltis 86 / Veozip	1269	1319	1369	1417	1466	1516	1566	1615	1672	1718	1768	1819	1868	56
	Sergé 1% / Soltis 92	1319	1373	1424	1473	1527	1578	1631	1683	1741	1788	1841	1895	1945	56
	Lacq [Ⓢ] + £298 [Ⓢ]	47	51	54	57	60	65	69	71	75	78	83	86	90	
3,25 - 3,01	Sergé 600 / Soltis 86 / Veozip	1293	1341	1395	1446	1498	1548	1603	1653	1710	1762	1814	1865	1918	62
	Sergé 1% / Soltis 92	1344	1396	1453	1503	1560	1612	1668	1721	1780	1835	1887	1942	1997	62
	Lacq [Ⓢ] + £298 [Ⓢ]	48	53	56	59	62	67	70	74	78	81	86	89	92	
3,50 - 3,26	Sergé 600 / Soltis 86 / Veozip	1315	1369	1423	1477	1532	1583	1637	1692	1750	1803	1857	1910	1967	65
	Sergé 1% / Soltis 92	1369	1424	1482	1537	1594	1648	1705	1761	1823	1879	1934	1988	2048	65
	Lacq [Ⓢ] + £298 [Ⓢ]	51	55	58	62	65	70	72	77	79	83	88	91	94	
3,75 - 3,51	Sergé 600 / Soltis 86 / Veozip	1338	1395	1448	1505	1564	1617	1674	1729	1790	1846	1903	1957	2013	70
	Sergé 1% / Soltis 92	1391	1452	1508	1567	1627	1685	1743	1800	1864	1923	1981	2040	2097	70
	Lacq [Ⓢ] + £298 [Ⓢ]	53	57	60	63	67	71	75	78	82	86	90	93	96	
4,00 - 3,76	Sergé 600 / Soltis 86 / Veozip	1362	1418	1477	1536	1593	1651	1710	1767	1831	1887	1945	2005	2062	74
	Sergé 1% / Soltis 92	1417	1474	1537	1599	1657	1718	1780	1840	1907	1967	2026	2088	2149	74
	Lacq [Ⓢ] + £298 [Ⓢ]	55	59	62	66	70	74	78	81	84	89	92	95	98	
4,25 - 4,01	Sergé 600 / Soltis 86 / Veozip	1382	1442	1503	1565	1624	1685	1747	1804	1872	1932	1991	2050	2112	79
	Sergé 1% / Soltis 92	1439	1502	1565	1630	1691	1754	1818	1880	1947	2011	2074	2136	2200	79
	Lacq [Ⓢ] + £298 [Ⓢ]	57	62	65	69	71	77	79	83	86	91	94	97	101	
4,50 - 4,26	Sergé 600 / Soltis 86 / Veozip	1407	1469	1533	1594	1655	1718	1780	1843	1910	1973	2036	2099	2161	84
	Sergé 1% / Soltis 92	1464	1529	1595	1658	1724	1788	1856	1921	1988	2055	2120	2188	2251	84
	Lacq [Ⓢ] + £298 [Ⓢ]	59	62	66	70	74	78	81	84	89	92	95	98	101	
4,75 - 4,51	Sergé 600 / Veozip	1430	1494	1559	1622	1687	1752	1818	1881	1949	2014	2081	2144	2209	90
	Sergé 1% / Soltis 92														90
	Lacq [Ⓢ] + £298 [Ⓢ]	62	66	70	72	77	81	84	88	91	95	98	101	105	
5,00 - 4,76	Sergé 600 / Veozip	1452	1518	1584	1652	1718	1787	1854	1919	1991	2056	2125	2192	2257	93
	Sergé 1% / Soltis 92														93
	Lacq [Ⓢ] + £298 [Ⓢ]	65	69	71	75	78	83	86	90	93	97	101	103	108	
5,25 - 5,01	Sergé 600 / Veozip	1476	1543	1611	1683	1750	1819	1887	1957	2031	2100	2169	2238	2308	97
	Sergé 1% / Soltis 92														97
	Lacq [Ⓢ] + £298 [Ⓢ]	67	70	74	78	81	86	89	92	95	100	102	107	109	
5,50 - 5,26	Sergé 600 / Veozip	1497	1568	1641	1711	1781	1855	1923	1994	2073	2142	2213	2283	2357	101
	Sergé 1% / Soltis 92														101
	Lacq [Ⓢ] + £298 [Ⓢ]	70	72	77	79	83	88	91	94	97	101	105	109	112	
5,75 - 5,51	Sergé 600 / Veozip	1520	1594	1667	1741	1816	1886	1962	2033	2111	2187	2257	2331	2403	108
	Sergé 1% / Soltis 92														108
	Lacq [Ⓢ] + £298 [Ⓢ]	71	75	78	82	86	90	93	96	100	103	108	110	115	
6,00 - 5,76	Sergé 600 / Veozip	1542	1617	1694	1769	1844	1919	1997	2073	2151	2226	2303	2378		110
	Sergé 1% / Soltis 92														110
	Lacq [Ⓢ] + £298 [Ⓢ]	74	78	81	84	89	92	95	98	101	107	109	114		

Without warranty

Motor	Sunea io + Situio 1 io	included												
	Maestria io + Situio 1 io	included												
	Orea WT motor + switch	-76	-76	-76	-76	-76	-76	-76	-76	-76	-76	-76	-76	-76

Ⓢ < 3 screens: Additional set-up cost of £298 / < 5 screens: Additional set-up cost of £150 / ≥ 5: no set-up cost Ⓢ The minimum width is also determined by the selected motor, see p. 54

B1350 ZIP

Width \ Height (m)		3,41 - 3,60	3,61 - 3,80	3,81 - 4,00	4,01 - 4,20	4,21 - 4,40	4,41 - 4,60 ^B	4,61 - 4,80 ^B	4,81 - 5,00 ^B	5,01 - 5,20 ^B	5,21 - 5,40 ^B	5,41 - 5,60 ^B	5,61 - 5,80 ^B	5,81 - 6,00 ^B	Surcharge spacing profile
		B1350 C ZIP + Sunea io + Situio 1 io (of Maestria io + Situio 1 io)													
3,00 - 2,76	Sergé 600 / Soltis 86 / Veozip	1919	1970	2022	2070	2119	2175	2226	2277	2326	2378	2427	2480	2529	56
	Sergé 1% / Soltis 92	2000	2051	2104	2157	2209									56
	Lacq ^C + £298 ^B	93	97	101	103	108	112	116	119	122	125	130	133	136	
3,00 - 3,01	Sergé 600 / Soltis 86 / Veozip	1970	2023	2076	2129	2179	2237	2287	2342	2393	2448	2499	2551	2603	62
	Sergé 1% / Soltis 92	2051	2106	2161	2215	2271									62
	Lacq ^C + £298 ^B	95	100	102	107	109	115	117	121	124	128	132	135	139	
3,50 - 3,26	Sergé 600 / Soltis 86 / Veozip	2020	2075	2130	2184	2238	2300	2351	2408	2460	2516	2570			65
	Sergé 1% / Soltis 92	2103	2160	2217	2274	2333									65
	Lacq ^C + £298 ^B	97	101	105	109	112	116	120	123	126	130	134			
3,75 - 3,51	Sergé 600 / Soltis 86 / Veozip	2070	2126	2184	2241	2296	2358	2417	2472	2529					70
	Sergé 1% / Soltis 92	2157	2214	2274	2334	2391									70
	Lacq ^C + £298 ^B	100	103	108	110	115	119	122	125	129					
4,00 - 3,76	Sergé 600 / Soltis 86 / Veozip	2119	2179	2237	2296	2357	2420	2480							74
	Sergé 1% / Soltis 92	2209	2271	2331	2391	2452									74
	Lacq ^C + £298 ^B	101	107	109	114	116	121	124							
4,25 - 4,01	Sergé 600 / Soltis 86 / Veozip	2172	2232	2291	2352	2415	2482								79
	Sergé 1% / Soltis 92	2264	2325	2388	2451	2514									79
	Lacq ^C + £298 ^B	103	109	112	116	119	123								
4,50 - 4,26	Sergé 600 / Soltis 86 / Veozip	2222	2284	2347	2412	2472									84
	Sergé 1% / Soltis 92	2315	2381	2446	2511	2577									84
	Lacq ^C + £298 ^B	107	110	115	117	121									
4,75 - 4,51	Sergé 600 / Veozip	2275	2340	2401											90
	Sergé 1% / Soltis 92														90
	Lacq ^C + £298 ^B	109	114	116											
5,00 - 4,76	Sergé 600 / Veozip	2324	2390												93
	Sergé 1% / Soltis 92														93
	Lacq ^C + £298 ^B	112	116												
5,25 - 5,01	Sergé 600 / Veozip	2377													97
	Sergé 1% / Soltis 92														97
	Lacq ^C + £298 ^B	115													
5,50 - 5,26	Screen / Veozip	2426													101
	Sergé 1% / Soltis 92														101
	Lacq ^C + £298 ^B	116													

Without warranty

Motor	Sunea io + Situio 1 io	included													
	Maestria io + Situio 1 io	included													
	Orea WT motor + schakelaar	-86	-86	-86	-86	-86	-86	-86	-86	-86	-86	-86	-86	-86	-86

^B Not possible as Soltis 86 (max 4,40m) ^C < 3 screens: Additional set-up cost of £298/ > 5 screens: Additional set-up cost of £150/ ≥ 5: no set-up cost

B1100 ZIP SOLAR

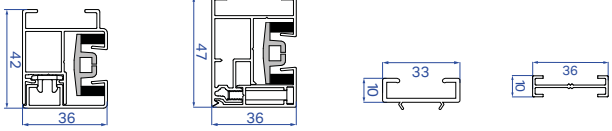

ZIP Clips rail
Standard

ZIP Screw Side rail
Option without
surcharge

Spacing profile
ZIP Clips

Spacing profile
ZIP Screw

Standard aluminum tubes & L-profiles available, list of types and prices in the standard colours, overview on page 94

No wind sensor in combination with RS100 io motor.

Colours

Standard Colours

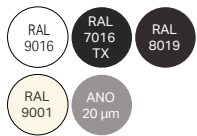

Other RAL-Colours



Set-up cost:
£298 (<3 screens),
£150 (<5 screens),
free (≥5 screens)

Bruster Preferred List
91

Special finish 90



Options

- 1 Operation 81
 - 2 Sensors 81
- Dooya 15-channels transmitter £32
- Choice between black or grey ZIP-rail New Included
- Sergé 600 Blockout LUNAR/SOLAR surcharge instead of Sergé 600 £41 / m²

Height (m)	Width	B1100 ZIP + RS100 io + Situo 1 + solar panel + battery																Surcharge spacing profile
		0,60 - 1,00 ^E	1,01 - 1,20	1,21 - 1,40	1,41 - 1,60	1,61 - 1,80	1,81 - 2,00	2,01 - 2,20	2,21 - 2,40	2,41 - 2,60	2,61 - 2,80	2,81 - 3,00	3,01 - 3,20	3,21 - 3,40	3,41 - 3,60	3,61 - 3,80	3,81 - 4,00	
0,75 - 0,80	Sergé 600 / Soltis 86 / Veozip	1095	1127	1160	1193	1279	1307	1334	1359	1385	1412	1438	1465	1491	1517	1544	1570	19
	Sergé 1% / Soltis 92	1128	1162	1195	1230	1317	1347	1374	1400	1426	1454	1482	1508	1537	1564	1593	1617	19
	Lacq ^C + £298 ^D	26	29	33	37	40	45	48	52	55	58	62	66	70	72	77	81	
1,00 - 0,76	Sergé 600 / Soltis 86 / Veozip	1117	1150	1186	1220	1313	1341	1371	1398	1426	1456	1483	1511	1540	1569	1598	1626	23
	Sergé 1% / Soltis 92	1150	1187	1223	1257	1353	1381	1412	1441	1472	1501	1530	1559	1588	1617	1649	1678	23
	Lacq ^C + £298 ^D	28	32	36	39	44	47	51	54	57	60	65	69	71	75	78	83	
1,25 - 1,01	Sergé 600 / Soltis 86 / Veozip	1138	1173	1210	1247	1348	1379	1410	1438	1469	1499	1530	1561	1592	1619	1651	1683	27
	Sergé 1% / Soltis 92	1173	1210	1248	1287	1386	1419	1451	1482	1516	1545	1578	1609	1643	1672	1705	1736	27
	Lacq ^C + £298 ^D	31	33	38	41	46	48	53	56	59	62	67	70	74	78	81	86	
1,50 - 1,26	Sergé 600 / Soltis 86 / Veozip	1160	1197	1236	1274	1380	1414	1445	1479	1510	1542	1577	1603	1641	1672	1706	1737	32
	Sergé 1% / Soltis 92	1196	1235	1275	1313	1422	1457	1489	1525	1558	1592	1626	1655	1693	1726	1761	1795	32
	Lacq ^C + £298 ^D	32	37	40	45	47	51	55	58	62	65	70	72	77	79	83	88	
1,75 - 1,51	Sergé 600 / Soltis 86 / Veozip	1182	1223	1263	1302	1414	1448	1483	1518	1551	1587	1620	1655	1690	1725	1760	1795	34
	Sergé 1% / Soltis 92	1220	1262	1302	1343	1457	1493	1530	1564	1602	1637	1673	1709	1746	1780	1818	1856	34
	Lacq ^C + £298 ^D	34	39	44	47	50	53	57	60	63	67	71	75	78	82	86	90	
2,00 - 1,76	Sergé 600 / Soltis 86 / Veozip	1204	1246	1287	1329	1448	1483	1521	1558	1594	1631	1668	1703	1740	1777	1812	1848	41
	Sergé 1% / Soltis 92	1243	1286	1329	1373	1493	1530	1568	1607	1645	1684	1720	1758	1797	1834	1873	1911	41
	Lacq ^C + £298 ^D	37	41	46	48	52	55	59	62	66	70	74	78	81	84	89	92	
2,25 - 2,01	Sergé 600 / Soltis 86 / Veozip	1226	1270	1314	1357	1482	1521	1559	1596	1636	1673	1713	1752	1789	1829	1868	1906	46
	Sergé 1% / Soltis 92	1267	1311	1355	1402	1529	1568	1608	1649	1688	1727	1770	1809	1848	1890	1931	1972	46
	Lacq ^C + £298 ^D	39	45	47	51	54	57	62	65	69	71	77	79	83	86	91	94	
2,50 - 2,26	Sergé 600 / Soltis 86 / Veozip	1248	1294	1340	1385	1517	1558	1596	1637	1677	1718	1759	1800	1839	1879	1921	1963	50
	Sergé 1% / Soltis 92	1288	1338	1383	1431	1564	1607	1649	1689	1732	1774	1818	1860	1901	1943	1986	2029	50
	Lacq ^C + £298 ^D	41	47	50	53	56	60	63	67	70	74	78	82	86	89	93	96	
2,75 - 2,51	Sergé 600 / Soltis 86 / Veozip	1271	1317	1364	1413	1550	1594	1636	1677	1719	1762	1805	1846	1890	1934			53
	Sergé 1% / Soltis 92	1311	1362	1411	1461	1601	1645	1688	1732	1775	1820	1864	1908	1953	1999			53
	Lacq ^C + £298 ^D	45	48	52	55	58	62	66	70	72	77	81	84	88	91			
3,00 - 2,76	Sergé 600 / Soltis 86 / Veozip	1292	1341	1392	1441	1586	1631	1673	1718	1763	1806	1851	1896	1940	1984			56
	Sergé 1% / Soltis 92	1334	1388	1438	1490	1636	1684	1727	1774	1821	1865	1913	1960	2006	2051			56
	Lacq ^C + £298 ^D	47	51	54	57	60	65	69	71	75	78	83	86	90	93			
Motor	RS100 Solar io + Situo 1 io	included																
	Dooya+15-channel transmitter ^D	-278	-213	-213	-213	-213	-213	-213	-213	-213	-213	-213	-213	-213	-213	-213	-213	-213

^C < 3 screens: Additional set-up cost of £298 / < 5 screens: Additional set-up cost of £150 / ≥ 5: no set-up cost ^D Minimum width 0,90 m ^E 0,60 - 0,79 available without warranty

^F The minimum width is also determined by the selected motor, see p. 54

Trade Price March 2026 exc VAT.

B1100 ZIP Prestige

SOLAR

- B1100 Prestige: tight, square box of 110 x 110mm.
- Lead rail partially disappears into the housing (Total height including bottom rail = 124 mm)
- Standard with Somfy RS100 io + **Situo** 1.
- Optional: Dooya motor with integrated battery + 15 channels transmitter

- Standard with ZIP Screw rails (36 x 54mm)
- Max width screen 3,5m / Max height screen: 3m
- Easy disassembly of the roller tube
- Min width screen with Somfy motor = 0,8m / with Dooya motor = 0,9m
- Standard with roller tube \varnothing 63mm diameter and PVC "anti-wrinkle" profile to prevent visible markings on the screen fabric

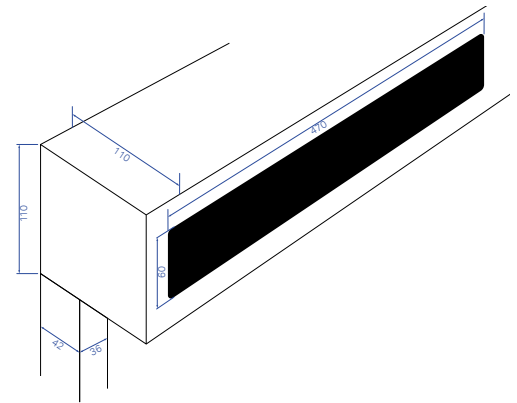

- 7 Somfy: 7 year warranty on motor + solar panel + battery
- 5 Dooya: 5 year warranty on motor + solar panel + battery



Solar by Somfy app

The app enables you to determine the possibilities of a Somfy Solar solution in advance and in a specific environment.

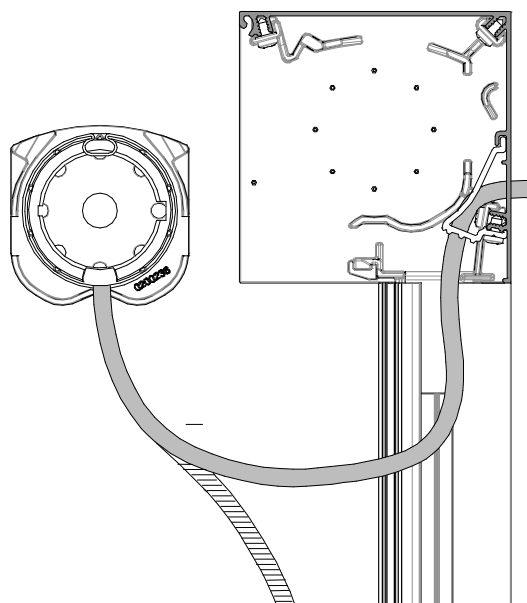
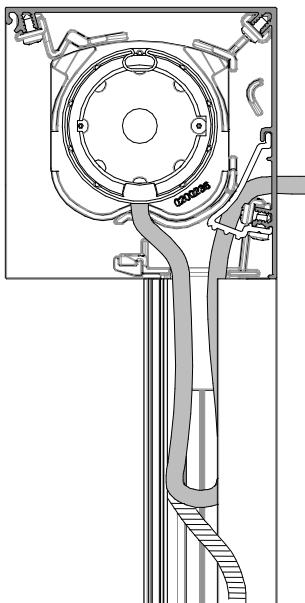

B1350 ZIP SOLAR

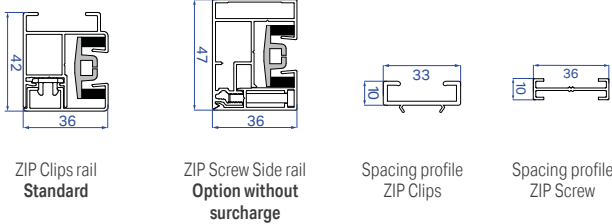

Standard aluminum tubes & L-profiles available, list of types and prices in the standard colours, overview on page 94

No wind sensor in combination with RS100 io motor.

Colours

Standard Colours

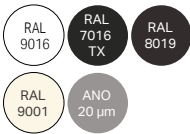

Other RAL-Colours



Set-up cost:
£298 (<3 screens),
£150 (<5 screens),
free (≥5 screens)

Brustor Preferred List
91

Special finish **90**



Options

- 1** Operation **81**
- 2** Sensors **81**
- Dooya 15-channels transmitter **£30**
- Choice between black or grey ZIP-rail **New** **Included**
- Sergé 600 Blockout LUNAR/SOLAR surcharge instead of Sergé 600 **£41 / m²**

Width	B1350 C ZIP + RS100 io + Situ 1 + solar panel + battery																		Surcharge spacing profile				
	0,90 - 1,00 F	1,01 - 1,20	1,21 - 1,40	1,41 - 1,60	1,61 - 1,80	1,81 - 2,00	2,01 - 2,20	2,21 - 2,40	2,41 - 2,60	2,61 - 2,80	2,81 - 3,00	3,01 - 3,20	3,21 - 3,40	3,41 - 3,60	3,61 - 3,80	3,81 - 4,00	4,01 - 4,20	4,21 - 4,40		4,41 - 4,60	4,61 - 4,80	4,81 - 5,00	
Height (m)																							
0,75 - 0,50	Sergé 600 / Soltis 86 / Veozip	1242	1273	1305	1336	1368	1398	1428	1460	1495	1525	1557	1587	1617	1649	1680	1713	1743	1773	1809	1840	1872	19
0,75 - 0,50	Sergé 1% / Soltis 92	1285	1317	1349	1382	1416	1448	1479	1510	1548	1580	1611	1646	1677	1710	1741	1775	1808	1838				19
	Lacq C + £298	26	29	33	37	40	45	48	52	55	58	62	66	70	72	77	81	84	88	91	95	98	
	Sergé 600 / Soltis 86 / Veozip	1266	1298	1331	1364	1398	1432	1464	1497	1535	1568	1602	1632	1664	1698	1731	1766	1798	1832	1869	1902	1937	23
1,00 - 0,76	Sergé 1% / Soltis 92	1310	1342	1379	1412	1448	1482	1517	1549	1589	1624	1658	1690	1726	1761	1795	1831	1864	1899				23
	Lacq C + £298	28	32	36	39	44	47	51	54	57	60	65	69	71	75	78	83	86	90	93	97	101	
	Sergé 600 / Soltis 86 / Veozip	1287	1322	1356	1392	1428	1462	1499	1535	1573	1609	1645	1679	1715	1751	1785	1820	1857	1890	1931	1965	2002	27
1,25 - 1,01	Sergé 1% / Soltis 92	1332	1368	1403	1441	1479	1512	1551	1589	1631	1668	1706	1740	1778	1816	1851	1888	1926	1962				27
	Lacq C + £298	31	33	38	41	46	48	53	56	59	62	67	70	74	78	81	86	89	92	95	100	102	
	Sergé 600 / Soltis 86 / Veozip	1311	1348	1382	1419	1457	1495	1535	1571	1612	1649	1687	1725	1761	1799	1836	1874	1911	1949	1990	2030	2065	32
1,50 - 1,26	Sergé 1% / Soltis 92	1355	1394	1432	1468	1508	1548	1589	1626	1671	1710	1750	1788	1825	1865	1904	1944	1983	2021				32
	Lacq C + £298	32	37	40	45	47	51	55	58	62	65	70	72	77	79	83	88	91	94	97	101	105	
	Sergé 600 / Soltis 86 / Veozip	1334	1373	1411	1448	1488	1527	1569	1608	1652	1690	1730	1771	1811	1851	1886	1926	1965	2005	2049	2090	2128	34
1,75 - 1,51	Sergé 1% / Soltis 92	1380	1420	1461	1500	1541	1582	1625	1667	1712	1753	1794	1836	1878	1919	1959	2002	2042	2083				34
	Lacq C + £298	34	39	44	47	50	53	57	60	63	67	71	75	78	82	86	90	93	96	100	103	108	
	Sergé 600 / Soltis 86 / Veozip	1356	1398	1438	1479	1519	1559	1604	1645	1689	1731	1774	1817	1857	1898	1942	1983	2025	2065	2114	2154	2196	41
2,00 - 1,76	Sergé 1% / Soltis 92	1403	1448	1489	1532	1573	1616	1662	1706	1752	1795	1839	1883	1926	1969	2014	2057	2102	2145				41
	Lacq C + £298	37	41	46	48	52	55	59	62	66	70	74	78	81	84	89	92	95	98	101	107	109	
	Sergé 600 / Soltis 86 / Veozip	1379	1422	1465	1508	1550	1594	1640	1682	1728	1774	1818	1862	1905	1948	1994	2037	2082	2125	2172	2217	2261	46
2,25 - 2,01	Sergé 1% / Soltis 92	1426	1472	1518	1563	1607	1651	1698	1742	1793	1839	1884	1931	1978	2021	2068	2113	2160	2205				46
	Lacq C + £298	39	45	47	51	54	57	62	65	69	71	77	79	83	86	91	94	97	101	103	109	112	
	Sergé 600 / Soltis 86 / Veozip	1402	1447	1493	1539	1583	1626	1674	1718	1770	1816	1862	1907	1952	2001	2046	2093	2137	2183	2234	2281	2392	50
2,50 - 2,26	Sergé 1% / Soltis 92	1452	1498	1545	1594	1641	1686	1735	1781	1834	1882	1931	1979	2026	2075	2123	2172	2218	2266				50
	Lacq C + £298	41	47	50	53	56	60	63	67	70	74	78	82	86	89	93	96	100	102	107	110	114	
	Sergé 600 / Soltis 86 / Veozip	1425	1473	1519	1568	1614	1662	1711	1756	1809	1857	1903	1952	2002	2050	2097	2147	2259	2306	2361	2408	2457	53
2,75 - 2,51	Sergé 1% / Soltis 92	1476	1525	1573	1624	1674	1721	1773	1821	1876	1926	1976	2026	2076	2126	2177	2226	2342	2394				53
	Lacq C + £298	45	48	52	55	58	62	66	70	72	77	81	84	88	91	95	98	101	105	109	113		
	Sergé 600 / Soltis 86 / Veozip	1448	1499	1548	1596	1647	1695	1746	1795	1851	1897	1947	2000	2048	2099	2150	2201	2317	2365				56
3,00 - 2,76	Sergé 1% / Soltis 92	1499	1552	1604	1653	1707	1756	1811	1862	1919	1968	2020	2074	2126	2178	2232	2283	2402	2454				56
	Lacq C + £298	47	51	54	57	60	65	69	71	75	78	83	86	90	93	97	101	103	108				
	Motor	included																					
RS100 Solar io + Situ 1 io																							
Dooya + 15-channels transmitter	-213	-213	-213	-213	-213	-213	-213	-213	-213	-213	-213	-213	-213	-213	-213	-213	-213	-213	-213	-213	-213	-213	Without warranty

Ⓢ < 3 screens: Additional set-up cost of £298 / < 5 screens: Additional set-up cost of £150 / ≥ 5: no set-up cost Ⓢ The minimum width is also determined by the selected motor, see p. 54

B1350 ZIP SOLAR

- B1350: square box of 135 x 135mm.
- Standard with Somfy RS100 io + Situ0 1
- Optional: Dooya motor with integrated battery + 15 channels transmitter
- Standard with ZIP Clips rails.
- Max width screen 5m / Max height screen: 3m / Max surface: 1.2m²

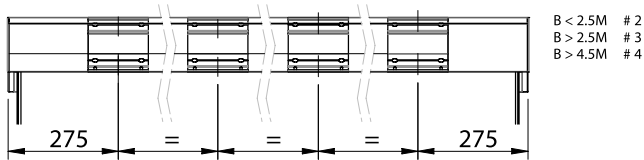

- Min width screen = 0,9m
- Standard with roller tube \varnothing 63mm diameter and PVC "anti-wrinkle" profile to prevent visible markings on the screen fabric.

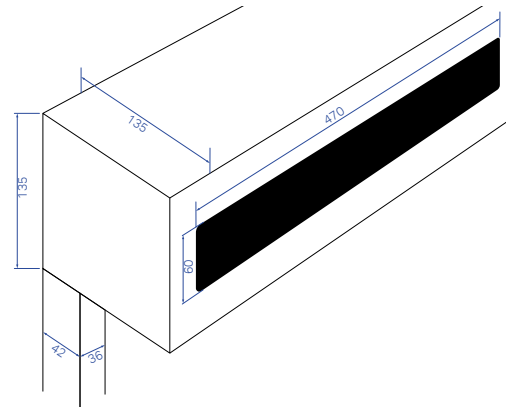

- 7 Somfy: 7 year warranty on motor + solar panel + battery
- 5 Dooya: 5 year warranty on motor + solar panel + battery



Solar by Somfy app

The app enables you to determine the possibilities of a Somfy Solar solution in advance and in a specific environment.



B1350 ZIP SOLAR

		Width																		Surcharge spacing profile			
		0,90 - 1,00	1,01 - 1,20	1,21 - 1,40	1,41 - 1,60	1,61 - 1,80	1,81 - 2,00	2,01 - 2,20	2,21 - 2,40	2,41 - 2,60	2,61 - 2,80	2,81 - 3,00	3,01 - 3,20	3,21 - 3,40	3,41 - 3,60	3,61 - 3,80	3,81 - 4,00	4,01 - 4,20	4,21 - 4,40		4,41 - 4,60	4,61 - 4,80	4,81 - 5,00
Height (m)		B1350 CZIP + solar panel + battery																					
0,75 - 0,50	Sergé 600 / Soltis 86 / Veozip	1304	1334	1365	1396	1428	1459	1489	1521	1556	1584	1615	1648	1677	1709	1740	1773	1802	1833	1867	1899	1929	19
	Sergé 1% / Soltis 92	1346	1379	1411	1442	1476	1507	1539	1571	1609	1640	1671	1706	1737	1769	1800	1834	1866	1897				19
	Lacq C + £298 D	26	29	33	38	40	45	48	52	55	58	62	66	69	72	76	81	83	88	91	95	98	
1,00 - 0,76	Sergé 600 / Soltis 86 / Veozip	1327	1358	1392	1425	1459	1493	1524	1558	1595	1628	1662	1691	1724	1758	1790	1825	1857	1890	1928	1960	1995	23
	Sergé 1% / Soltis 92	1370	1402	1439	1472	1507	1542	1577	1610	1649	1684	1718	1750	1784	1820	1854	1889	1923	1958				23
	Lacq C + £298 D	28	31	36	39	44	47	51	53	57	60	65	68	71	76	78	83	86	90	93	97	100	
1,25 - 1,01	Sergé 600 / Soltis 86 / Veozip	1349	1383	1417	1453	1489	1522	1559	1595	1633	1669	1705	1739	1774	1811	1844	1879	1916	1949	1989	2024	2060	27
	Sergé 1% / Soltis 92	1393	1428	1464	1501	1539	1573	1611	1649	1690	1727	1764	1798	1836	1874	1908	1946	1983	2019				27
	Lacq C + £298 D	31	33	39	41	46	48	53	56	59	62	67	70	75	77	81	84	89	91	95	99	102	
1,50 - 1,26	Sergé 600 / Soltis 86 / Veozip	1373	1409	1442	1480	1518	1556	1595	1631	1672	1709	1747	1783	1820	1858	1895	1932	1970	2007	2048	2088	2123	31
	Sergé 1% / Soltis 92	1416	1455	1493	1529	1568	1609	1649	1686	1729	1769	1810	1847	1885	1924	1963	2003	2041	2078				31
	Lacq C + £298 D	32	38	40	45	47	51	55	58	61	65	69	72	76	79	83	88	91	94	97	101	104	
1,75 - 1,51	Sergé 600 / Soltis 86 / Veozip	1395	1433	1470	1508	1548	1588	1629	1668	1712	1750	1789	1830	1869	1908	1944	1985	2024	2064	2108	2148	2186	34
	Sergé 1% / Soltis 92	1440	1481	1522	1560	1602	1642	1685	1726	1772	1812	1853	1895	1937	1978	2018	2060	2099	2140				34
	Lacq C + £298 D	34	39	44	47	50	53	57	60	63	67	71	76	78	82	86	90	93	96	99	103	107	
2,00 - 1,76	Sergé 600 / Soltis 86 / Veozip	1417	1459	1499	1539	1579	1617	1664	1705	1749	1790	1833	1875	1916	1957	2001	2041	2083	2123	2172	2212	2254	41
	Sergé 1% / Soltis 92	1464	1507	1549	1592	1633	1676	1721	1764	1812	1854	1898	1942	1985	2027	2072	2115	2159	2203				41
	Lacq C + £298 D	38	41	46	48	52	55	59	62	66	69	75	77	81	83	89	91	95	98	101	105	109	
2,25 - 2,01	Sergé 600 / Soltis 86 / Veozip	1440	1483	1526	1568	1610	1654	1699	1741	1788	1833	1878	1921	1964	2006	2052	2095	2139	2181	2230	2275	2318	46
	Sergé 1% / Soltis 92	1487	1532	1578	1622	1667	1711	1758	1801	1852	1898	1943	1989	2035	2078	2126	2171	2218	2263				46
	Lacq C + £298 D	39	45	47	51	53	57	61	65	68	71	76	79	83	86	91	94	97	100	103	108	113	
2,50 - 2,26	Sergé 600 / Soltis 86 / Veozip	1463	1506	1552	1599	1643	1686	1734	1778	1829	1874	1921	1966	2011	2058	2104	2151	2195	2241	2292	2338	2383	50
	Sergé 1% / Soltis 92	1511	1559	1605	1653	1700	1745	1795	1841	1893	1941	1989	2036	2084	2133	2180	2229	2277	2323				50
	Lacq C + £298 D	41	47	50	53	56	60	63	67	70	75	78	82	84	89	93	96	99	102	105	111	114	
2,75 - 2,51	Sergé 600 / Soltis 86 / Veozip	1486	1533	1579	1628	1674	1721	1771	1816	1867	1916	1961	2011	2060	2108	2155	2204	2251	2298	2352	2399	2448	53
	Sergé 1% / Soltis 92	1537	1584	1633	1684	1734	1781	1833	1880	1935	1983	2033	2084	2134	2183	2234	2284	2334	2385				53
	Lacq C + £298 D	45	48	52	55	58	62	66	69	72	76	81	83	88	91	95	98	101	104	109	113		
3,00 - 2,76	Sergé 600 / Soltis 86 / Veozip	1507	1559	1608	1655	1707	1754	1804	1854	1908	1956	2005	2057	2106	2157	2208	2258	2307	2356				56
	Sergé 1% / Soltis 92	1559	1612	1664	1713	1766	1816	1869	1921	1978	2026	2077	2132	2182	2235	2288	2340	2392	2445				56
	Lacq C + £298 D	47	51	53	57	60	65	68	71	76	78	83	86	90	93	97	100	103	107				
Motor	Sunea 40 DC RTS + Situo 1 RTS	included																					
	Dooya + 15-channels transmitter D	-283	-283	-283	-283	-283	-283	-283	-283	-283	-283	-283	-283	-283	-283	-283	-283	-283	-283	-283	-283	-283	

C < 3 screens: Additional set-up cost of £298 / < 5 screens: Additional set-up cost of £150 / ≥5: no Set-up cost **D** Minimum width: 0,90m.



B1100 ZIP

Corner screen

- Max width: 4m motor side / 3m gear side.
- Max height: 3m / Always with a fixed angle of 90°.
- Motor always fixated on the widest side and at the outside.
- Motor side ≥ gear side.
- Blackout fabric Blockout Lunar £ 38m²

TOTAL PRICE = A + B (+ Lacq)

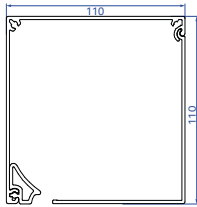

B1100 C

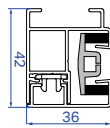

ZIP Clips rail
Standard

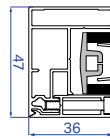

ZIP Screw side rail
Option without surcharge

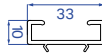

Spacing profile
ZIP Screw

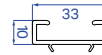

Spacing profile
Zip Screw
(available from juli 2023)

Motor side

		Width	B1100 ZIP Corner screen + Sunilus io + Situo 1 io / Altus RTS + Situo 1 RTS													Surcharge spacing profile		
			1,01 - 1,20	1,21 - 1,40	1,41 - 1,60	1,61 - 1,80	1,81 - 2,00	2,01 - 2,20	2,21 - 2,40	2,41 - 2,60	2,61 - 2,80	2,81 - 3,00	3,01 - 3,20	3,21 - 3,40	3,41 - 3,60		3,61 - 3,80	3,81 - 4,00
A	1,00 - 0,76	Sergé 600 / Soltis 86 / Veozip	1536	1568	1603	1635	1669	1700	1733	1772	1804	1837	1867	1900	1935	1967	2001	24
		Sergé 1% / Soltis 92	1580	1615	1648	1685	1718	1753	1787	1825	1860	1895	1926	1961	1997	2030	2066	24
		Lacq ☉ + £ 298 ☉	31	36	39	44	47	51	53	57	60	65	68	71	76	78	83	
	1,25 - 1,01	Sergé 600 / Soltis 86 / Veozip	1560	1593	1629	1666	1699	1736	1772	1811	1845	1881	1916	1951	1987	2019	2055	27
		Sergé 1% / Soltis 92	1605	1641	1677	1715	1750	1789	1825	1866	1903	1941	1974	2012	2050	2085	2123	27
		Lacq ☉ + £ 298 ☉	33	39	41	46	48	53	56	59	62	67	70	75	77	81	84	
	1,50 - 1,26	Sergé 600 / Soltis 86 / Veozip	1584	1619	1655	1693	1731	1772	1808	1848	1885	1923	1960	1997	2034	2071	2109	31
		Sergé 1% / Soltis 92	1631	1669	1706	1745	1785	1825	1863	1906	1944	1986	2024	2062	2100	2138	2179	31
		Lacq ☉ + £ 298 ☉	38	40	45	47	51	55	58	61	65	69	72	76	79	83	88	
	1,75 - 1,51	Sergé 600 / Soltis 86 / Veozip	1610	1648	1685	1725	1763	1805	1844	1888	1926	1966	2006	2047	2085	2124	2162	34
		Sergé 1% / Soltis 92	1656	1698	1737	1778	1818	1861	1901	1947	1989	2029	2071	2113	2154	2194	2235	34
		Lacq ☉ + £ 298 ☉	39	44	47	50	53	57	60	63	67	71	76	78	82	86	90	
	2,00 - 1,76	Sergé 600 / Soltis 86 / Veozip	1635	1675	1715	1755	1795	1841	1881	1925	1967	2010	2051	2093	2133	2176	2218	41
		Sergé 1% / Soltis 92	1685	1726	1769	1811	1852	1898	1941	1988	2030	2074	2118	2160	2204	2249	2293	41
		Lacq ☉ + £ 298 ☉	41	46	48	52	55	59	62	66	69	75	77	81	83	89	91	
	2,25 - 2,01	Sergé 600 / Soltis 86 / Veozip	1658	1701	1745	1788	1831	1875	1918	1964	2010	2053	2097	2139	2182	2229	2271	46
		Sergé 1% / Soltis 92	1709	1754	1798	1843	1887	1935	1978	2028	2074	2119	2167	2212	2256	2301	2347	46
		Lacq ☉ + £ 298 ☉	45	47	51	53	57	61	65	68	71	76	79	83	86	91	94	
2,50 - 2,26	Sergé 600 / Soltis 86 / Veozip	1683	1729	1775	1819	1863	1909	1955	2005	2050	2097	2142	2188	2234	2280	2326	49	
	Sergé 1% / Soltis 92	1735	1781	1830	1877	1921	1970	2016	2070	2117	2167	2213	2260	2307	2357	2405	49	
	Lacq ☉ + £ 298 ☉	47	50	53	56	60	63	67	70	75	78	82	84	89	93	96		
2,75 - 2,51	Sergé 600 / Soltis 86 / Veozip	1710	1755	1804	1851	1898	1946	1992	2044	2091	2137	2188	2235	2285	2331	2380	53	
	Sergé 1% / Soltis 92	1760	1811	1860	1909	1958	2009	2055	2111	2159	2211	2260	2310	2360	2411	2461	53	
	Lacq ☉ + £ 298 ☉	48	52	55	58	62	66	69	72	76	81	83	88	91	95	98		
3,00 - 2,76	Sergé 600 / Soltis 86 / Veozip	1736	1784	1832	1882	1930	1981	2030	2085	2132	2181	2233	2282	2333	2383	2434	56	
	Sergé 1% / Soltis 92	1789	1841	1888	1942	1992	2045	2097	2154	2202	2255	2307	2361	2411	2464	2516	56	
	Lacq ☉ + £ 298 ☉	51	53	57	60	65	68	71	76	78	83	86	90	93	97	103		
Motor	Sunilus io + Situo 1 io	included																
	Maestria io + Situo 1 io	66	66	66	66	66	66	66	66	66	66	66	66	66	66	66	66	
	Altus WT motor + switch	-34	-34	-34	-34	-34	-34	-34	-34	-34	-34	-34	-34	-34	-34	-34	-34	

☉ < 3 screens: Additional set-up cost of £298 / < 5 screens: Additional set-up cost of £150 / ≥5: no Set-up cost.

B1100 ZIP

Corner screen



Colours

Standard Colours

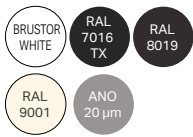

Other RAL-colours see table



Set-up cost:
£298 (<3 screens),
£150 (<5 screens),
free (≥5 screens)

Brustor Preferred List



Special finish



Gear side

		Width										Surcharge spacing profile	
		1,01 - 1,20	1,21 - 1,40	1,41 - 1,60	1,61 - 1,80	1,81 - 2,00	2,01 - 2,20	2,21 - 2,40	2,41 - 2,60	2,61 - 2,80	2,81 - 3,00		
Height (m)		B1100 ZIP Corner screen gear side											
B	1,00 - 0,76	Sergé 600 / Soltis 86 / Veozip	914	947	980	1013	1047	1079	1111	1143	1181	1215	24
		Sergé 1% / Soltis 92	957	991	1025	1060	1096	1129	1165	1197	1237	1271	24
		Lacc ☉ + £298	31	36	39	44	47	51	53	57	60	65	
	1,01 - 1,01	Sergé 600 / Soltis 86 / Veozip	935	971	1003	1039	1076	1109	1146	1181	1221	1255	27
		Sergé 1% / Soltis 92	981	1017	1053	1088	1126	1161	1200	1237	1277	1314	27
		Lacc ☉ + £298	33	39	41	46	48	53	56	59	62	67	
	1,25 - 1,25	Sergé 600 / Soltis 86 / Veozip	959	995	1031	1067	1105	1143	1181	1217	1259	1296	31
		Sergé 1% / Soltis 92	1002	1041	1079	1116	1157	1196	1237	1274	1317	1356	31
		Lacc ☉ + £298	38	40	45	47	51	55	58	61	65	69	
	1,50 - 1,26	Sergé 600 / Soltis 86 / Veozip	981	1021	1059	1097	1137	1174	1216	1254	1298	1337	34
		Sergé 1% / Soltis 92	1028	1068	1108	1147	1188	1230	1272	1313	1358	1399	34
		Lacc ☉ + £298	39	44	47	50	53	57	60	63	67	71	
	1,75 - 1,51	Sergé 600 / Soltis 86 / Veozip	1003	1047	1086	1126	1166	1206	1250	1292	1337	1378	41
		Sergé 1% / Soltis 92	1053	1096	1137	1180	1221	1262	1309	1352	1398	1440	41
		Lacc ☉ + £298	41	46	48	52	55	59	62	66	69	75	
	2,00 - 1,76	Sergé 600 / Soltis 86 / Veozip	1027	1069	1112	1157	1199	1242	1286	1329	1375	1421	46
		Sergé 1% / Soltis 92	1075	1120	1166	1210	1254	1298	1344	1389	1438	1485	46
		Lacc ☉ + £298	45	47	51	53	57	61	65	68	71	76	
	2,25 - 2,01	Sergé 600 / Soltis 86 / Veozip	1050	1094	1140	1186	1231	1274	1321	1365	1417	1462	49
		Sergé 1% / Soltis 92	1099	1144	1193	1241	1287	1331	1381	1427	1481	1529	49
		Lacc ☉ + £298	47	50	53	56	60	63	67	70	75	78	
	2,50 - 2,26	Sergé 600 / Soltis 86 / Veozip	1074	1122	1166	1215	1262	1309	1357	1402	1455	1502	53
		Sergé 1% / Soltis 92	1124	1172	1221	1271	1321	1368	1419	1467	1522	1571	53
		Lacc ☉ + £298	48	52	55	58	62	66	69	72	76	81	
2,75 - 2,51	Sergé 600 / Soltis 86 / Veozip	1146	1195	1243	1292	1342	1392	1440	1497	1543	1593	56	
	Sergé 1% / Soltis 92	1200	1250	1298	1353	1402	1456	1506	1566	1612	1666	56	
	Lacc ☉ + £298	51	53	57	60	65	68	71	76	78	83		
3,00 - 2,76	Sergé 600 / Soltis 86 / Veozip	1146	1195	1243	1292	1342	1392	1440	1497	1543	1593	56	
	Sergé 1% / Soltis 92	1200	1250	1298	1353	1402	1456	1506	1566	1612	1666	56	
	Lacc ☉ + £298	51	53	57	60	65	68	71	76	78	83		

☉ < 3 screens: Additional set-up cost of **£298** / < 5 screens: Additional set-up cost of **£150** / ≥ 5: **no Set-up cost**. Trade Price March 2026 exc VAT.



B1200 ZIP Built-in screen

- Standard with Somfy Sunilus io.
- Box and side guides entirely built-in.
- Lead rail integrated in the screen box.
- To be placed at the same time as the window.
- Screen developed for an easier dismantling of the roller tube.
- B1200: square box of 165mm x 120mm.

- Max dimensions Screen: 12m² surface / 5m wide / 3,5m high.
- Max dimensions Soltis: 12m² surface / 4,4m wide / 3,5m high.
- Roller tube of $\varnothing 78\text{mm} \leq 4\text{m} / \varnothing 85\text{mm} > 4\text{m}$
- The B1200 ZIP is available with side guide with flat end piece or side guide with end piece with an inclination of 5° (*fig 1*)

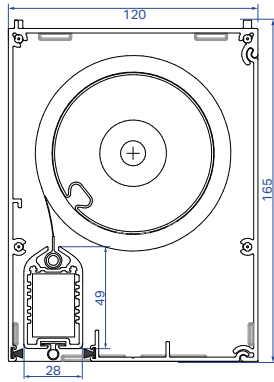

B1200 Box

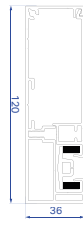

Side rail Standard

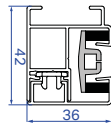

ZIP Clips rail
Option without surcharge

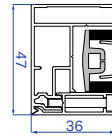

ZIP Screw side rail
Option without surcharge

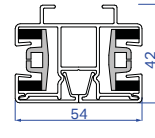

ZIP Coupled rail

		Width																					
		0,80 - 1,00	1,01 - 1,20	1,21 - 1,40	1,41 - 1,60	1,61 - 1,80	1,81 - 2,00	2,01 - 2,20	2,21 - 2,40	2,41 - 2,60	2,61 - 2,80	2,81 - 3,00	3,01 - 3,20	3,21 - 3,40	3,41 - 3,60	3,61 - 3,80	3,81 - 4,00	4,01 - 4,20	4,21 - 4,40	4,41 - 4,60 ^B	4,61 - 4,80 ^B	4,81 - 5,00 ^B	
Height(m)		B1200 ZIP + Somfy Sunilus io + Situio 1 io																					
0,75	Sergé 600 / Soltis 86 / Veozip	1074	1105	1137	1167	1236	1270	1298	1332	1362	1396	1427	1458	1490	1524	1554	1588	1628	1658	1692	1724	1757	
	Sergé 1% / Soltis 92	1101	1138	1174	1211	1288	1328	1363	1402	1441	1478	1518	1554	1594	1632	1670	1708	1754	1791				
	Lacq ^C + £298 ^B	30	34	39	42	47	52	55	59	62	67	70	76	79	82	86	90	94	98	103	105	111	
1,00 - 0,75	Sergé 600 / Soltis 86 / Veozip	1113	1144	1178	1211	1285	1320	1353	1388	1420	1455	1490	1524	1559	1592	1627	1662	1704	1736	1772	1806	1841	
	Sergé 1% / Soltis 92	1144	1186	1228	1267	1349	1391	1432	1473	1515	1557	1598	1641	1680	1721	1764	1805	1855	1898				
	Lacq ^C + £298 ^B	33	38	40	45	49	53	58	60	65	68	72	77	81	84	89	91	97	102	104	109	113	
1,25 - 1,01	Sergé 600 / Soltis 86 / Veozip	1150	1186	1222	1255	1332	1370	1406	1444	1478	1515	1550	1588	1626	1662	1697	1731	1777	1814	1851	1887	1925	
	Sergé 1% / Soltis 92	1190	1234	1277	1321	1410	1454	1499	1544	1589	1633	1677	1722	1767	1813	1856	1902	1957	2003				
	Lacq ^C + £298 ^B	35	39	44	47	52	56	60	63	68	71	76	80	83	88	91	96	98	104	105	112	115	
1,50 - 1,25	Sergé 600 / Soltis 86 / Veozip	1190	1229	1266	1304	1382	1420	1460	1497	1536	1573	1612	1651	1690	1729	1767	1806	1852	1890	1930	1968	2008	
	Sergé 1% / Soltis 92	1235	1283	1329	1376	1469	1518	1566	1612	1663	1711	1759	1809	1855	1903	1952	2002	2060	2108				
	Lacq ^C + £298 ^B	39	42	46	49	54	58	62	67	69	74	77	81	86	90	94	98	101	104	111	114	118	
1,75 - 1,51	Sergé 600 / Soltis 86 / Veozip	1230	1269	1309	1348	1432	1473	1512	1553	1595	1635	1675	1715	1757	1797	1837	1879	1927	1967	2009	2049	2091	
	Sergé 1% / Soltis 92	1280	1330	1381	1431	1529	1579	1633	1685	1735	1788	1839	1890	1944	1995	2047	2098	2159	2211				
	Lacq ^C + £298 ^B	40	45	48	52	56	60	65	68	72	76	80	83	89	92	97	100	104	108	113	117	120	
2,00 - 1,76	Sergé 600 / Soltis 86 / Veozip	1269	1310	1352	1394	1480	1524	1566	1608	1651	1693	1737	1781	1823	1866	1907	1952	2004	2045	2088	2132	2176	
	Sergé 1% / Soltis 92	1326	1378	1432	1485	1589	1644	1700	1754	1810	1865	1920	1974	2031	2085	2141	2196	2260	2316				
	Lacq ^C + £298 ^B	44	47	50	53	59	62	68	71	76	79	82	86	91	95	98	102	105	111	115	119	122	
2,25 - 2,01	Sergé 600 / Soltis 86 / Veozip	1308	1351	1395	1438	1529	1573	1619	1665	1710	1754	1798	1844	1889	1935	1979	2025	2077	2123	2169	2214	2260	
	Sergé 1% / Soltis 92	1370	1426	1484	1541	1648	1708	1766	1825	1885	1943	2002	2061	2118	2177	2235	2296	2361	2422				
	Lacq ^C + £298 ^B	46	49	53	56	60	66	69	74	77	81	84	89	94	98	101	104	109	113	117	121	125	
2,50 - 2,26	Sergé 600 / Soltis 86 / Veozip	1347	1393	1438	1484	1578	1627	1673	1719	1766	1814	1861	1907	1957	2004	2049	2097	2152	2201				
	Sergé 1% / Soltis 92	1415	1476	1535	1595	1708	1770	1833	1894	1958	2019	2082	2145	2204	2267	2329	2392	2464	2524				
	Lacq ^C + £298 ^B	48	52	54	58	63	68	72	76	80	83	87	91	96	100	104	108	112	115				
2,75 - 2,51	Sergé 600 / Soltis 86 / Veozip	1385	1433	1482	1529	1628	1677	1725	1774	1825	1874	1924	1971	2023	2072	2121	2170						
	Sergé 1% / Soltis 92	1460	1522	1588	1650	1767	1833	1900	1964	2031	2097	2160	2226	2294	2359	2426	2491						
	Lacq ^C + £298 ^B	50	53	57	60	67	70	76	79	82	86	90	94	98	103	105	111						
3,00 - 2,76	Sergé 600 / Soltis 86 / Veozip	1425	1475	1525	1574	1675	1727	1779	1832	1883	1934	1987	2036	2087	2140								
	Sergé 1% / Soltis 92	1504	1572	1638	1706	1829	1898	1966	2035	2104	2175	2242	2312	2382	2448								
	Lacq ^C + £298 ^B	53	56	59	62	68	72	77	81	84	89	91	97	102	104								
3,25 - 3,01	Sergé 600 / Soltis 86 / Veozip	1463	1515	1909	1620	1725	1779	1833	1885	1940	1994	2047	2100	2155									
	Sergé 1% / Soltis 92	1548	1617	1690	1759	1888	1961	2033	2106	2178	2251	2323	2397	2468									
	Lacq ^C + £298 ^B	54	58	61	66	71	76	80	83	88	91	96	98	104									
3,50 - 3,26	Sergé 600 / Soltis 86 / Veozip	1420	1469	1854	1571	1622	1672	1722	1774	1824	1874	1924	1973	2026									
	Sergé 1% / Soltis 92	1502	1570	1640	1707	1775	1843	1910	1979	2048	2115	2183	2252	2320									
	Lacq ^C + £298 ^B	53	56	60	63	67	70	76	78	82	86	91	93	98									
Motor	Sunilus io + Situio 1 io	included																					
	Maestria io + Situio 1 io	66	66	66	66	66	66	66	66	66	66	66	66	66	66	66	66	66	66	66	66	66	66
	Somfy LT motor + switch	-34	-34	-34	-34	-34	-34	-34	-34	-34	-34	-34	-34	-34	-34	-34	-34	-34	-34	-34	-34	-34	-34

^B Not possible as Soltis 86 (max 4,40m) ^C < 3 screens: Additional set-up cost of £298 / > 5 screens: Additional set-up cost of £150 / ≥5: no Set-up cost. Trade Price March 2026 exc VAT.

B1200 ZIP Built-in screen Coupled

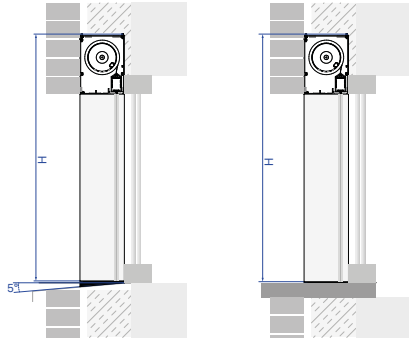

fig 1 side rail with flat end piece 5°

Options

Sergé 600 Blockout LUNAR surcharge instead of Soltis 86 **£ 45m²**



Sensors & transmitters **81**



Sensors **81**



Altus WT motor + switch **Table**

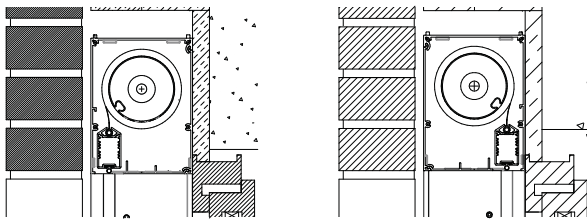

reverse mounting

standard mounting

Colours

Standard Colours



Other RAL-colours see table

Special finish **90**







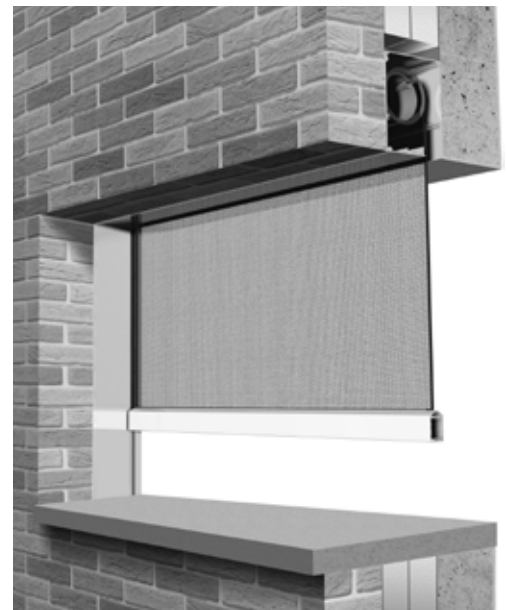

Set-up cost: **£298** (<3 screens), **£150** (<5 screens), **free** (≥5 screens)

Height(m)	Width	4,00 - 4,40	4,41 - 4,80	4,81 - 5,20	5,21 - 5,60	5,61 - 6,00	6,01 - 6,40	6,41 - 6,80	6,81 - 7,20	
		B1200 ZIP coupled								
0,75	Sergé 600 / Soltis 86 / Veozip	2409	2473	2536	2602	2666	2729	2793	2859	
	Sergé 1% / Soltis 92	2538	2617	2694	2767	2846	2921	2998	3072	
	Lacq £ +283	108	117	123	132	139	149	156	163	
1,00 - 0,75	Sergé 600 / Soltis 86 / Veozip	2516	2583	2654	2721	2791	2859	2926	2996	
	Sergé 1% / Soltis 92	2675	2756	2840	2924	3006	3091	3171	3254	
	Lacq £ +283	113	121	129	137	143	153	160	168	
1,25 - 1,01	Sergé 600 / Soltis 86 / Veozip	2623	2696	2767	2840	2913	2985	3059	3132	
	Sergé 1% / Soltis 92	2808	2897	2988	3077	3167	3258	3346	3436	
	Lacq £ +283	118	126	134	142	151	158	164	173	
1,50 - 1,25	Sergé 600 / Soltis 86 / Veozip	2730	2805	2883	2960	3038	3116	3191	3269	
	Sergé 1% / Soltis 92	2940	3038	3134	3232	3329	3427	3521	3619	
	Lacq £ +283	122	131	138	147	155	163	171	179	
1,75 - 1,51	Sergé 600 / Soltis 86 / Veozip	2834	2917	3000	3079	3162	3242	3324	3407	
	Sergé 1% / Soltis 92	3075	3180	3283	3386	3488	3594	3698	3799	
	Lacq £ +283	128	135	142	152	159	167	175	184	
2,00 - 1,76	Sergé 600 / Soltis 86 / Veozip	2943	3027	3116	3199	3287	3371	3457	3544	
	Sergé 1% / Soltis 92	3208	3320	3429	3541	3650	3763	3873	3982	
	Lacq £ +283	132	140	149	157	164	172	179	193	
2,25 - 2,01	Sergé 600 / Soltis 86 / Veozip	3050	3139	3229	3320	3409	3499	3590	3681	
	Sergé 1% / Soltis 92	3342	3461	3579	3694	3812	3929	4047	4164	
	Lacq £ +283	137	146	153	161	168	177	185	194	
2,50 - 2,26	Sergé 600 / Soltis 86 / Veozip	3158	3250	3345	3438	3533	3628	3724	3816	
	Sergé 1% / Soltis 92	3476	3600	3725	3850	3975	4099	4221	4346	
	Lacq £ +283	142	151	158	166	173	182	189	198	
2,75 - 2,51	Sergé 600 / Soltis 86 / Veozip	3262	3362	3461	3558	3658	3754	3854	3955	
	Sergé 1% / Soltis 92	3611	3740	3873	4004	4134	4266	4398	4527	
	Lacq £ +283	149	156	163	172	179	187	195	202	
3,00 - 2,76	Sergé 600 / Soltis 86 / Veozip	3369	3474	3576	3678	3783	3885	3986	4091	
	Sergé 1% / Soltis 92	3742	3881	4020	4160	4296	4434	4572	4710	
	Lacq £ +283	153	160	168	176	184	193	200	208	
3,25 - 3,01	Sergé 600 / Soltis 86 / Veozip	3476	3583	3690	3798	3905	4013	4122		
	Sergé 1% / Soltis 92	3877	4022	4166	4314	4459	4602	4748		
	Lacq £ +283	158	164	173	180	188	197	204		
3,50 - 3,26	Sergé 600 / Soltis 86 / Veozip	3268	3369	3469	3568	3670	3771	3874		
	Sergé 1% / Soltis 92	3644	3780	3917	4056	4191	4325	4462		
	Lacq £ +283	150	156	163	171	177	186	193		
Motor	Sunilus io + Situo 1 io	included								
	Maestria io + Situo 1 io	66	66	66	66	66	66	66	66	
	Somfy LT motor + switch	-34	-34	-34	-34	-34	-34	-34	-34	

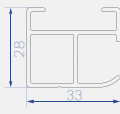
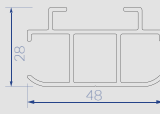
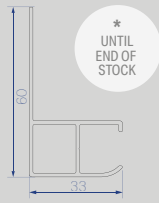
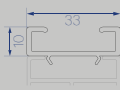
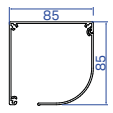

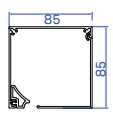
⊗ Not possible as Soltis 86 (max 4,40m) ⊕ < 3 screens: Additional set-up cost of £298 / < 5 screens: Additional set-up cost of £150 / ≥5: no Set-up cost. Trade Price March 2026 exc VAT.

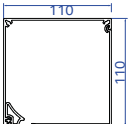
Standard screens profiles overview

	Box with lead rail	ZIP rail		Optional	
		ZIP Clips rail	Coupled rail	Side fix rail*	Spacing profile
					
B1085 SR	  Width Simple: max 3,6m Coupled: max 7,2m Height max 3,5m	✓	✓	✓	✓
B1085 C	  Width Simple: max 3,6m Coupled: max 7,2m Height max 3,5m	✓	✓	✓	✓
B1100 SR	  Width Simple: max 4,0m Coupled: max 7,2m Height max 4,0m	✓	✓	✓	✓
B1100 C	  Width Simple: max 4,0m Coupled: max 7,2m Height max 4,0m	✓	✓	✓	✓

Scale 1/100
In metres
width horizontal
height vertical

Standard screens

Application limits



B1085 Standard screens: max dimensions and application limits

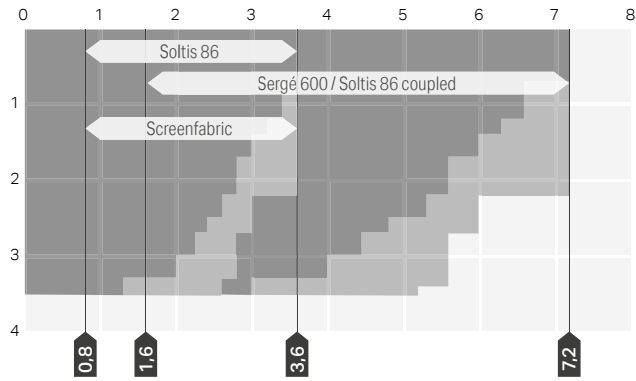

B1100 Standard screens: max dimensions and application limits

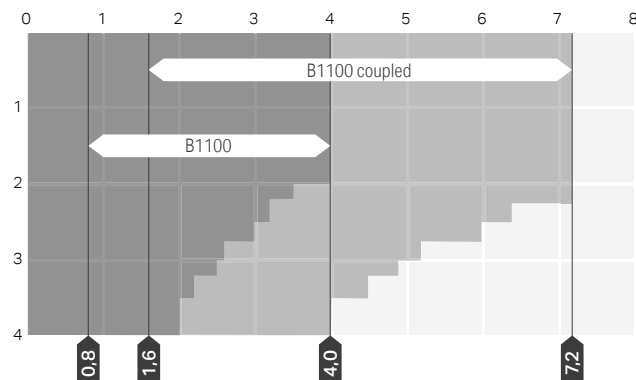

Windblocker

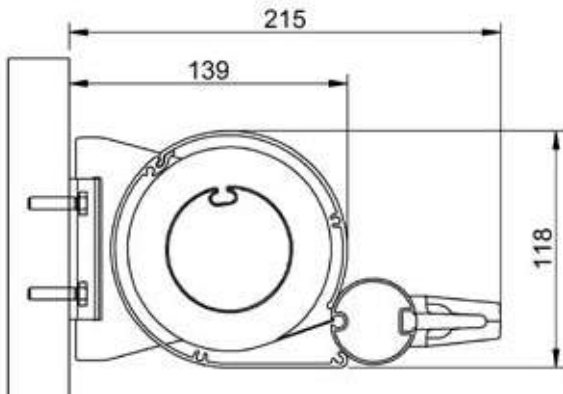

- Protects against wind and provides privacy in exposed locations.
- The box is always mounted on the wall. On the other side: wall fixation or pole fixation.
- Delivered with pole, wall fixation, hook fixation and handle.
- New: guided with support wheel.
- New: fabric locking system against winding.
- Maximum width 4m / height: 2m (Soltis 86: 1,860m).
- Heavy duty spring system ensures fabric remains taut.
- In case of wall fixation and height $\geq 1,5\text{m}$: standard with 2 handles and 2 hooks.
- Windclass 2

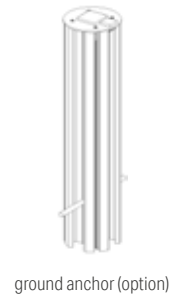
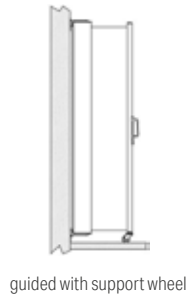
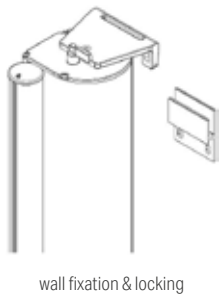
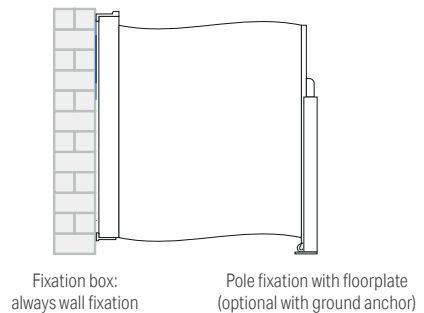
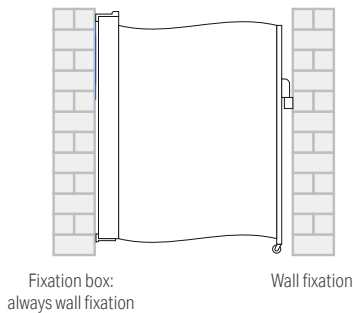

Options

Ground anchor which allows easy removal of the pole **£ 142**

Only available with Acrylic fabric class 1 & 2 and Soltis 86
 Not available with fabric heavier such as Soltis 92.
 Bonings only for Soltis 86

Colours

Standard Colours



Other RAL-colours see table



Brustor Preferred List



Special finish





Prices per projection / height

Height	Projection				Lacc [ⓐ] + £298 [ⓑ]
	No fabric	2m	3m	4m [ⓑ]	
1,27m - 1,50m	£536	£735	£832	£928	£44
1,50m - 2,00m	£587	£767	£860	£956	£54
Surcharge bonings Only for Soltis 86		£119 (1 piece)	£153 (2 pieces)	£186 (3 pieces)	

[ⓐ] Maximum height Soltis 86: 1,86m [ⓑ] Without bonings = No warranty less tension in fabric possible. [ⓐ] Additional set-up cost of £298 regardless of the dimensions and quantity.

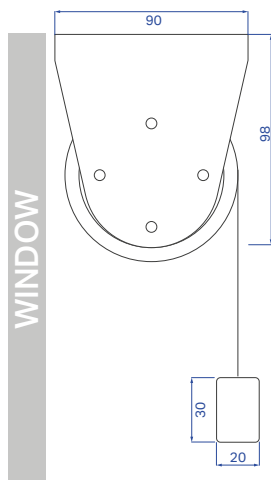
Features and benefits



- Screen for interior use, standard with Somfy io motor.
 - Fabric with inox fixation system and front profile in aluminium, without rails.
 - Maximum dimensions Screen: 18m² surface / 6m wide / 6m high.
 - Maximum dimensions Soltis: 18m² surface / 4,4m wide / 4,5m high.
 - Roller tube diameter depends on width and height
- Info about motors and transmitters  **83**

Options

Sergé 600 Blockout LUNAR surcharge instead of Soltis 86
Indoor Natté 400 fabric = price of Soltis 92
Lacqued supports



Sunea io

Sensors



Altus WT motor + switch

Colours

£ 45m²

Table
£19



Table

 **81**

 For a larger width, we cannot offer warranty due to the risk of wrinkle formation.

Table

Standard Colours

Other RAL-colours see table

Special finish 

 Set-up cost:
£298 (<3 screens),
£150 (<5 screens),
free (≥5 screens)

 **90**

Brustor Preferred List

 **91**

Indoor Screen

		Width	0,80 - 1,00	1,01 - 1,20	1,21 - 1,40	1,41 - 1,60	1,61 - 1,80	1,81 - 2,00	2,01 - 2,20	2,21 - 2,40	2,41 - 2,60	2,61 - 2,80	2,81 - 3,00	3,01 - 3,20	3,21 - 3,40
			Indoor screen + Sunilus io motor + Situio 1 io												
0,75 - 0,50	Sergé 600 / Soltis 86	761	779	798	814	832	851	870	886	907	921	942	959	977	
	Sergé 1% / Soltis 92	788	807	826	844	864	881	901	921	939	958	978	995	1015	
	Lacq £298	16	17	19	23	25	28	30	33	35	39	41	45	47	
1,00 - 0,76	Sergé 600 / Soltis 86	772	790	813	832	852	874	891	914	932	955	973	994	1016	
	Sergé 1% / Soltis 92	802	819	843	864	884	907	926	949	966	990	1012	1032	1055	
	Lacq £298	16	17	19	23	25	28	30	33	35	39	41	45	47	
1,25 - 1,01	Sergé 600 / Soltis 86	784	805	825	851	874	893	917	940	961	985	1006	1029	1053	
	Sergé 1% / Soltis 92	811	835	856	881	907	928	953	977	997	1023	1045	1069	1094	
	Lacq £298	16	17	19	23	25	28	30	33	35	39	41	45	47	
1,50 - 1,26	Sergé 600 / Soltis 86	795	818	846	870	891	917	943	965	991	1018	1039	1063	1090	
	Sergé 1% / Soltis 92	825	849	876	900	926	953	980	1001	1028	1055	1079	1105	1132	
	Lacq £298	16	17	19	23	25	28	30	33	35	39	41	45	47	
1,75 - 1,51	Sergé 600 / Soltis 86	776	800	817	839	857	878	898	919	942	961	983	1002	1025	
	Sergé 1% / Soltis 92	838	865	891	919	948	977	1001	1031	1058	1087	1113	1143	1170	
	Lacq £298	16	17	19	23	25	28	30	33	35	39	41	45	47	
2,00 - 1,76	Sergé 600 / Soltis 86	819	848	877	907	932	961	991	1020	1049	1077	1106	1137	1165	
	Sergé 1% / Soltis 92	851	879	911	939	966	997	1028	1058	1089	1117	1148	1179	1210	
	Lacq £298	16	17	19	23	25	28	30	33	35	39	41	45	47	
2,25 - 2,01	Sergé 600 / Soltis 86	832	861	891	922	955	985	1018	1045	1077	1107	1140	1170	1203	
	Sergé 1% / Soltis 92	864	893	926	958	990	1023	1055	1085	1117	1149	1184	1216	1249	
	Lacq £298	16	17	19	23	25	28	30	33	35	39	41	45	47	
2,50 - 2,26	Sergé 600 / Soltis 86	846	877	911	943	974	1006	1039	1073	1105	1140	1172	1206	1241	
	Sergé 1% / Soltis 92	876	911	943	980	1013	1045	1079	1113	1147	1184	1217	1253	1288	
	Lacq £298	16	17	19	23	25	28	30	33	35	39	41	45	47	
2,75 - 2,51	Sergé 600 / Soltis 86	854	890	927	960	995	1031	1063	1100	1137	1170	1206	1242	1277	
	Sergé 1% / Soltis 92	886	923	960	996	1033	1070	1105	1143	1179	1216	1253	1290	1328	
	Lacq £298	16	17	19	23	25	28	30	33	35	39	41	45	47	
3,00 - 2,76	Sergé 600 / Soltis 86	870	907	943	981	1018	1055	1091	1128	1165	1203	1239	1277	1314	
	Sergé 1% / Soltis 92	900	940	980	1018	1056	1095	1133	1172	1210	1249	1287	1328	1365	
	Lacq £298	16	17	19	23	25	28	30	33	35	39	41	45	47	
3,25 - 3,01	Sergé 600 / Soltis 86	880	919	959	997	1036	1077	1115	1153	1195	1233	1272	1313	1351	
	Sergé 1% / Soltis 92	914	955	995	1036	1077	1117	1159	1201	1243	1281	1322	1364	1404	
	Lacq £298	16	17	19	23	25	28	30	33	35	39	41	45	47	
3,50 - 3,26	Sergé 600 / Soltis 86	891	933	974	1018	1058	1100	1141	1183	1224	1267	1309	1349	1390	
	Sergé 1% / Soltis 92	926	969	1013	1056	1099	1143	1185	1229	1272	1317	1360	1402	1447	
	Lacq £298	16	17	19	23	25	28	30	33	35	39	41	45	47	
3,75 - 3,51	Sergé 600 / Soltis 86	907	949	992	1035	1079	1122	1167	1210	1254	1297	1342	1384	1431	
	Sergé 1% / Soltis 92	939	985	1029	1076	1121	1167	1212	1257	1305	1349	1395	1440	1486	
	Lacq £298	16	17	19	23	25	28	30	33	35	39	41	45	47	
4,00 - 3,76	Sergé 600 / Soltis 86	916	963	1007	1055	1100	1146	1194	1237	1285	1329	1377	1422	1468	
	Sergé 1% / Soltis 92	951	998	1047	1096	1143	1190	1241	1286	1336	1382	1432	1478	1527	
	Lacq £298	16	17	19	23	25	28	30	33	35	39	41	45	47	
4,25 - 4,01	Sergé 600 / Soltis 86	929	977	1025	1073	1122	1169	1217	1266	1314	1361	1411	1459	1506	
	Sergé 1% / Soltis 92	964	1015	1063	1113	1165	1215	1266	1316	1365	1417	1466	1518	1566	
	Lacq £298	16	17	19	23	25	28	30	33	35	39	41	45	47	
4,50 - 4,26	Sergé 600 / Soltis 86	942	991	1041	1091	1142	1195	1243	1292	1344	1395	1444	1496	1544	
	Sergé 1% / Soltis 92	978	1028	1082	1133	1186	1242	1291	1344	1396	1451	1502	1556	1607	
	Lacq £298	16	17	19	23	25	28	30	33	35	39	41	45	47	
4,75 - 4,51	Sergé 600	953	1002	1058	1110	1164	1215	1269	1321	1374	1426	1477	1532	1584	
	Lacq £298	16	17	19	23	25	28	30	33	35	39	41	45	47	
	Sergé 600	964	1020	1074	1130	1184	1239	1292	1349	1402	1459	1511	1568	1620	
5,00 - 4,76	Lacq £298	16	17	19	23	25	28	30	33	35	39	41	45	47	
	Sergé 600	978	1033	1091	1147	1205	1262	1318	1377	1433	1490	1547	1604	1663	
	Lacq £298	16	17	19	23	25	28	30	33	35	39	41	45	47	
5,25 - 5,01	Sergé 600	990	1049	1106	1167	1225	1285	1344	1402	1462	1522	1581	1641		
	Lacq £298	16	17	19	23	25	28	30	33	35	39	41	45		
	Sergé 600	999	1062	1125	1185	1247	1309	1370	1432	1494	1554	1614	1677		
5,50 - 5,26	Lacq £298	16	17	19	23	25	28	30	33	35	39	41	45		
	Sergé 600	1015	1077	1141	1204	1269	1330	1395	1459	1522	1585	1649			
	Lacq £298	16	17	19	23	25	28	30	33	35	39	41			
6,00 - 5,76	Sunilus io + Situio 1 io	included													
	Sunea io	14	14	14	14	14	14	14	14	14	14	14	14	14	14
	Somfy LT + switch	-115	-115	-115	-115	-115	-115	-115	-115	-115	-115	-115	-115	-115	-115

< 3 screens: Additional set-up cost of **£298** / < 5 screens: Additional set-up cost of **£150** / ≥5: **no Set-up cost.**

Price index on the next page

Indoor Screen

		Width												
		3,41 - 3,60	3,61 - 3,80	3,81 - 4,00	4,01 - 4,20	4,21 - 4,40	4,41 - 4,60 ^B	4,61 - 4,80 ^B	4,81 - 5,00 ^B	5,01 - 5,20 ^B	5,21 - 5,40 ^B	5,41 - 5,60 ^B	5,61 - 5,80 ^B	5,81 - 6,00 ^B
Height(m)	Indoor screen + Sunilus io motor + Situo 1 io													
	0,75-0,80	Sergé 600 / Soltis 86	994	1015	1031	1049	1065	1085	1103	1121	1138	1158	1173	1194
Sergé 1% / Soltis 92		1032	1053	1070	1089	1106								
Lacq ^C + £298 ^B		50	52	54	56	60	61	65	68	70	72	76	78	81
1,00-0,76	Sergé 600 / Soltis 86	1034	1055	1074	1095	1113	1137	1153	1174	1196	1217	1236	1257	1277
	Sergé 1% / Soltis 92	1074	1096	1113	1138	1159								
	Lacq ^C + £298 ^B	50	52	54	56	60	61	65	68	70	72	76	78	81
1,25-1,01	Sergé 600 / Soltis 86	1074	1096	1117	1141	1165	1186	1208	1232	1254	1276	1297	1321	1344
	Sergé 1% / Soltis 92	1113	1140	1162	1185	1210								
	Lacq ^C + £298 ^B	50	52	54	56	60	61	65	68	70	72	76	78	81
1,50-1,26	Sergé 600 / Soltis 86	1113	1138	1164	1188	1211	1237	1260	1286	1312	1336	1360	1384	1411
	Sergé 1% / Soltis 92	1158	1183	1208	1233	1259								
	Lacq ^C + £298 ^B	50	52	54	56	60	61	65	68	70	72	76	78	81
1,75-1,51	Sergé 600 / Soltis 86	1152	1180	1207	1234	1260	1288	1314	1342	1368	1396	1422	1448	1475
	Sergé 1% / Soltis 92	1200	1226	1254	1285	1310								
	Lacq ^C + £298 ^B	50	52	54	56	60	61	65	68	70	72	76	78	81
2,00-1,76	Sergé 600 / Soltis 86	1195	1223	1253	1280	1310	1339	1368	1397	1426	1455	1485	1512	1543
	Sergé 1% / Soltis 92	1242	1271	1302	1330	1361								
	Lacq ^C + £298 ^B	50	52	54	56	60	61	65	68	70	72	76	78	81
2,25-2,01	Sergé 600 / Soltis 86	1233	1266	1296	1328	1358	1389	1420	1453	1485	1514	1546	1577	1609
	Sergé 1% / Soltis 92	1281	1316	1347	1381	1412								
	Lacq ^C + £298 ^B	50	52	54	56	60	61	65	68	70	72	76	78	81
2,50-2,26	Sergé 600 / Soltis 86	1272	1308	1340	1374	1405	1440	1474	1506	1542	1574	1608	1643	1676
	Sergé 1% / Soltis 92	1322	1359	1393	1427	1462								
	Lacq ^C + £298 ^B	50	52	54	56	60	61	65	68	70	72	76	78	81
2,75-2,51	Sergé 600 / Soltis 86	1314	1349	1383	1420	1456	1491	1529	1564	1601	1634	1671	1708	1741
	Sergé 1% / Soltis 92	1365	1402	1438	1477	1512								
	Lacq ^C + £298 ^B	50	52	54	56	60	61	65	68	70	72	76	78	81
3,00-2,76	Sergé 600 / Soltis 86	1351	1390	1430	1466	1504	1543	1580	1617	1655	1692	1730	1770	1810
	Sergé 1% / Soltis 92	1404	1447	1485	1526	1565								
	Lacq ^C + £298 ^B	50	52	54	56	60	61	65	68	70	72	76	78	81
3,25-3,01	Sergé 600 / Soltis 86	1394	1433	1473	1512	1553	1593	1634	1673	1714	1755	1793		
	Sergé 1% / Soltis 92	1448	1490	1532	1572	1614								
	Lacq ^C + £298 ^B	50	52	54	56	60	61	65	68	70	72	76		
3,50-3,26	Sergé 600 / Soltis 86	1433	1474	1518	1559	1604	1645	1686	1729	1774				
	Sergé 1% / Soltis 92	1490	1533	1579	1622	1668								
	Lacq ^C + £298 ^B	50	52	54	56	60	61	65	68	70				
3,75-3,51	Sergé 600 / Soltis 86	1473	1518	1561	1607	1650	1693	1740						
	Sergé 1% / Soltis 92	1532	1579	1625	1671	1716								
	Lacq ^C + £298 ^B	50	52	54	56	60	61	65						
4,00-3,76	Sergé 600 / Soltis 86	1512	1559	1607	1651	1700								
	Sergé 1% / Soltis 92	1572	1622	1671	1718	1769								
	Lacq ^C + £298 ^B	50	52	54	56	60								
4,25-4,01	Sergé 600 / Soltis 86	1554	1604	1650	1700									
	Sergé 1% / Soltis 92	1616	1668	1716	1769									
	Lacq ^C + £298 ^B	50	52	54	56									
4,50-4,26	Sergé 600 / Soltis 86	1596	1646	1698										
	Sergé 1% / Soltis 92	1661	1713	1766										
	Lacq ^C + £298 ^B	50	52	54										
5,00-4,76	Sergé 600	1636												
	Lacq ^C + £298 ^B	50												
	Sergé 600	1677												
Motor	Lacq ^C + £298 ^B	50												
	Sunilus io + Situo 1 io	included												
	Sunea io	14	14	14	14	14	14	14	14	14	14	14	14	14
	Somfy LT + switch	-115	-115	-115	-115	-115	-115	-115	-115	-115	-115	-115	-115	-115

^B Not possible as Soltis 86 (max 4.40m) ^C < 3 screens: Additional set-up cost of £298 / < 5 screens: Additional set-up cost of £150 / ≥5: no Set-up cost.

io Motors, Sensors, Transmitters



io-homecontrol®, safe technology

Brand-transcending wireless technology. As a result your solar shading will be compatible with a whole range of other appliances and operation types such as your iOS or Android devices, Apple Homepod, Google home and Amazon Alexa.

- ✔ Modular and very easily expandable
- ✔ Smart home: ready for the future
- ✔ Feedback function: reports back to your remote about the position of the product. You can check if it has opened or closed well, without you being there
- ✔ Safe: encryption of wireless communication between products

Motors

Sunilus io

- Set the upper and end-limit yourself.
- Set&Go io setting to program in a group.

Sunea io

- Both manual and automatic set-up.
- Only set the end limit.

Maestria io

- With obstacle detection.
- 3 levels of closing force
- Both manual and automatic set-up.
- 17 rotations per minute.

surcharge £81

Sunea CSI io

- io motor with manual override function

RS100 Solar io

- solar-powered io motor
- silent motor with slow stop / slow start function
- no wind sensor can be connected to the RS100 Solar io motor

Operation



Situo 1 io	Situo 1 io Var	Situo 5 io	Situo 5 io Var A/M	Nina	Smoove io	Smoove 4 io	Smoove 3 outdoor io	Situo 5 io/RTS Bi-Radio
1 channel io	1 channel io	5 channels io	5 channels io	60 channels io	1 channel io	4 channels io	3 channels io	5 channels io/RTS
• Pure £66 • Iron £93	• Pure £122 • Iron £143	• Pure £83 • Iron £132	• Pure £163 • Iron £185	£346	£66	£117	£74	• White £154

Operate your solar shading with your smartphone, wherever you are.

With **Tahoma Switch** you can operate your solar shading by means of a very user-friendly app on your smartphone. **Tahoma Switch** namely ensures that your smart device can communicate with io appliances. Tahoma Switch increases your comfort and safety.

£334

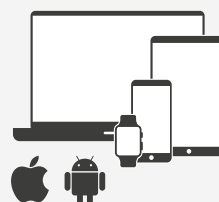

Sensors



Eolis 3D Wirefree io

Wirefree wind sensor.
Can be built in (153 x 38 x 25 mm) (white/black/brons)

£136



Eolis io battery

Wind sensor.

£162



Eolis io 230 Volt

Wind sensor.

£118



Soliris io 230 Volt

Sun- and wind sensor.



Rain sensor can be connected
To be set via Situo 5 VAR A/M transmitter

£217



Ondeis

Rain and snowsensor.

£284



Sunis Wirefree io

Wirefree Sun sensor
+ temperature

£104

Electric accesories

White motor cable 5m

Surcharge black motor cable 5m

Surcharge white motor cable 10m

included

£16

£16

Patio heater



io io-receiver
homecontrol integrated

2200 Watt Patio heater

Electrical IP65 patio heater 2200W with integrated io-receiver.

Delivered with fixation brackets on the backside of the awnings and with support to mount on the wall

Dimensions: L 90 cm x H 17 cm x D 15,5 cm

Weight 5,6 kg

Colours: Black and White (Silver housing)

Dimmable: Yes

⚠ **Advisable transmitter:**

Situo 5 io Var A/M

£1222

Trade Price March 2026 exc VAT.



2000 Watt Patio heater

Electrical IP65 patio heater 2000 W delivered with fixation brackets on the backside of the awnings and with support to mount on the wall.

Dimensions: L 54 cm x H 10 cm x D 15 cm / weight 2,4 kg

Colours Black, Anodised and White

£460

Technical info Motors

Motors for awnings

		Electronic stop		With manual override	
Couple / number of arms		Wireless Somfy Sunea io A	Traditional Orea WT B	Traditional NHK motor B	Wireless Somfy Sunea CSI io motor B
Awnings	40Nm / 2	473	371	562	543
	55Nm / 3	521	414	609	
	70Nm / 4	560	450	661	
	100Nm / 6	646	523	714	

Motors for screens, projection- and conservatory awnings

		Roller tube ø (mm)	Control with transmitter			Control with transmitter		Control with switch		
			Somfy Sunilus io A	Somfy Sunea io A	Somfy Maestria io A	RS100 Solar io 10 Nm A D	Dooya Solar 20 Nm C E	Somfy LT B	Altus WT B	Orea WT B
Zip screens	B1085 ZIP (15 Nm)	ø 63 mm	289	360	393				311	
	B1100 ZIP (Prestige) (15 Nm)	ø 78 mm	289	360	393				311	
	B1200 ZIP (25 Nm)	ø 78 - 85		424	393				311	
	B1350 ZIP (25 Nm)	ø 85 - 100		424	393					371
	B1100 ZIP (Prestige) Solar	ø 63 mm				283	288			0
	B1350 ZIP Solar	ø 63 - 78				283	288			0
	Topscreen (25 Nm)	ø 78 mm		424						371
	Topscreen Solar						288			
Indoor screens	Indoor (< 4m) (15 Nm)	ø 63 mm	289	360	393			222	311	
	Indoor (≥ 4m) (15 Nm)	ø 78 - 85	289	360	393			222	311	
Projection awnings	B2085 (15 Nm)	ø 50 / ø 63		360						275 F
	B2100 1 part (15 Nm)	ø 63 mm		360						275
	B2100 2 parts (20 Nm)	ø 63 mm		360						371
Conservatory awnings	B126 1 part (55 Nm)	ø 85 mm		521				386		414
	B126 2 parts (85 Nm)	ø 85 mm		585				470		489
	B127 (55 Nm)	ø 85 mm		521				386		414
	B128 (55 Nm)	ø 100 mm		521				386		414

A transmitter not included **B** switch not included **C** transmitter / switch not included **D** battery and solar panel not included **E** battery included, solar panel not included **F** only for roller tube ø63mm

WT Motors, Sensors, Transmitters

Bedrade Motors



Wired technology Fully wired installation (control with switch)

Operate your awning through a fully wired installation (fixed switch). Limited possibilities and not compatible with Somfy smart home. Higher installation cost because of the mounting of cable trays and slots in the wall.

Motors

Orea WT

- Adjustment without access to the motor head.
- Parallel switching of different motors is possible.
- Perfect closure of the housing.

Altus WT

- Adjustment without access to the motor head.
- Parallel switching of different motors is possible.

Somfy LT

- Silent motor.
- Ideal for switch control.
- Easy to install.
- The end limit can be programmed precisely by means of push buttons.

until out of stock



NHK

- Wired
- with manual override

Wall fixation switches

- 1 Wall fixation switch
- 1 Additional wall fixation switch
- 2 Surcharge recessed switch
- 3 Surcharge waterproof outdoor switch



Elektric accessories

included	Relay box RI-2 for 2 motors	£126
£17	Relay box RI-3 for 3 motors	£187
£23	Hirschmann plug	£28
£63	White motor cable 3m for Somfy LT	included
	Surcharge black motor cable 3m for Somfy LT	£18
	Surcharge motor cable 10m for Somfy LT	£18

Bristor has the right to change information or products from the Wired Technology range at any time and without prior notice

Price calculation for printing

Acryl (Valance + fabric)

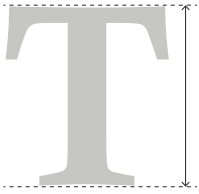

Painted text on valance / fabric	
Set-up costs	£191
Letter height	price / letter
< 15 cm	£33
< 20 cm	£37
< 25 cm	£42
< 30 cm	£54
< 40 cm	£122
< 50 cm	£183

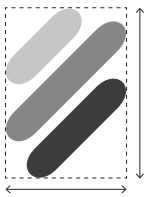

Painted logo on fabric		
Set-up costs £191		
	Number of colours	price
1 m ²	1	£561
	2	£777
	3	£1006
	4	£1176
2 m ²	1	£690
	2	£882
	3	£1171
	4	£1378
3 m ²	1	£887
	2	£1148
	3	£1189
	4	£1633

Painted logo on valance		
Set-up costs £191		
Number	Number of colours	price / logo
1	1 to 4	£282
2	1 to 4	£187
3	1 to 4	£164
4	1 to 4	£134

Printed logo on valance / fabric (limited dimensions)		
Set-up costs £191		
	Number of colours	price / piece
Max dimensions 15 x 30 cm	1	£141
	Quadri (CMYK)	£191
	Quadri (CMYK)	£141
	Quadri (CMYK)	£96
Max dimensions 20 x 40 cm	1	£160
	Quadri (CMYK)	£233
	Quadri (CMYK)	£160
	Quadri (CMYK)	£115

Soltis (Valance + fabric)

Painted text on valance / fabric	
Set-up costs	£191
Letter height	price / letter
< 15 cm	£33
< 20 cm	£37
< 25 cm	£42
< 30 cm	£54
< 40 cm	£122
< 50 cm	£183

Painted logo on fabric		
Set-up costs £191		
	Number of colours	price
1 m ²	1	£561
	2	£777
	3	£1006
	4	£1176
2 m ²	1	£690
	2	£882
	3	£1171
	4	£1378
3 m ²	1	£887
	2	£1148
	3	£1189
	4	£1633

Painted logo on valance		
Set-up costs £191		
Number	Number of colours	price / logo
1	1 to 4	£282
2	1 to 4	£187
3	1 to 4	£164
4	1 to 4	£134

Printed logo on valance / fabric (limited dimensions)		
Set-up costs £191^A		
	Number of colours	price / piece
Max dimensions 15 x 30 cm	1	£141
	Quadri (CMYK)	£191
	Quadri (CMYK)	£141
	Quadri (CMYK)	£96
Max dimensions 20 x 40 cm	1	£160
	Quadri (CMYK)	£233
	Quadri (CMYK)	£160
	Quadri (CMYK)	£115

^A There are no set-up costs if any letters also need to be painted.



Important

The customer may make a maximum of 2 changes, otherwise a supplement of **£32** will be charged.

Font and/or logo have to be delivered by the client in vector format.

Photoprint op Screen & Soltis

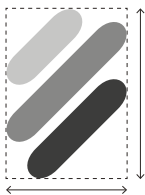

Colour on white fabric / Black on coloured fabric

Set-up costs £191	
surface	price / m ²
< 5 m ²	£128
< 10m ²	£97
≥ 10m ²	£76

White on coloured fabric (3 layers printed, incl. coating)

Set-up costs £191	
surface	price / m ²
< 5 m ²	£246
< 10m ²	£209
≥ 10m ²	£176

Examples

Painted text on Acryl valance / fabric

Letter height: 21 cm
Number of letters: 7

Price calculation:
£191 Set-up costs + (7 x £42) = **£485**

Painted logo on Acryl valance / fabric

Surface: 1 m²
Number of colours: 1

Price calculation:
£191 Set-up costs + £561 = **£752**

Printed logo on Acryl valance / fabric

Number: 1 (15 x 30 cm)
Number of colours: 1

Price calculation:
£191 Set-up costs + £141 = **£332**

Printed text on Soltis valance / fabric

Letter height: 15 cm
Number of letters: 5

Price calculation:
£191 Set-up costs + (5 x £33) = **£356**

Printed logo on Soltis valance / fabric

Number: 1 (15 x 30 cm)
Number of colours: 1

Price calculation:
£191 Set-up costs + £141 = **£332**

Photoprint on Screen / Soltis

Surface: 1 m²
Type: Colour on white fabric

Price calculation:
£191 Set-up costs + £128 = **£319**

Fabric covers

Tips and remarks

- Light grey Teflon sewing thread.
- Made to measure fabrics for sunprotection are supplied with top and bottom hem of 2,50cm.
- Fabric plastic bar with 6mm diameter included.
- Fabrics are always packed in special cylinder to avoid folds during transportation.
- Mandatory: awning type and dimensions of the finished fabric size need to be specified
- Pictures or logos for imprints need to be supplied as digital files and approved by the customer.
- Up to 7m width standard with profile clip for an easier replacement of the fabric (without removing the roller tube)

Options

Surcharge for a sewing thread in black instead of grey

£49net

Price reduction without profile clip

- £13/m

Surcharge for gluing instead of sewing (not possible with acryl fabrics for conservatory awning or fabric with a wider part of 7,5m on the B35 Elite awnings)

£29 net

Surcharge fabric in one part with reinforcement (10mm)

£334

⚠ No more tourniquets, eyelets, eyelets with turn caps, or abnormal shape possible

Options imprints

Options imprints

 **85**

	N° of stripes Width	1	2	3	4	5	6	7	Surcharge > 8,170m £ / m
		1,095	2,295	3,470	4,645	5,820	6,995	8,170	
Projection		Valance with standard height of 21cm							
valance straight	Fabric class 1	41	50	56	76	82	98	126	18
	Fabric class 2 - 3	55	61	71	96	103	128	164	25
valance waved	Fabric class 1	52	60	71	93	103	124	157	24
	Fabric class 2 - 3	65	76	83	114	124	154	195	30
price per 5cm extra	Fabric class 1	9	11	12	13	14	16	16	3
	Fabric class 2 - 3	9	12	14	16	17	19	19	4

	N° of stripes Width	1	2	3	4	5	6	7	Surcharge > 8,170m £ / m	Cover joint
		1,095	2,295	3,470	4,645	5,820	6,995	8,170		
Projection		Fabric								
≤ 100	Fabric class 1	103	163	226	283	349	408	365	51	
	Fabric class 2	109	178	245	312	385	449	412	65	
	Fabric class 3	119	195	272	346	428	499	474	77	
101 - 150	Fabric class 1	118	195	271	344	425	498	472	63	78
	Fabric class 2	130	216	302	385	476	558	543	83	89
	Fabric class 3	140	238	338	432	535	632	624	98	98
151 - 200	Fabric class 1	143	233	328	416	513	601	587	78	93
	Fabric class 2	157	260	366	467	577	678	682	102	104
	Fabric class 3	171	291	411	531	655	772	787	121	121
201 - 250	Fabric class 1	187	293	403	507	618	721	726	91	108
	Fabric class 2	203	323	450	569	696	815	832	120	124
	Fabric class 3	220	361	504	643	791	929	965	144	144
251 - 300	Fabric class 1	202	323	448	567	695	814	832	104	124
	Fabric class 2	220	360	503	642	788	927	964	139	143
	Fabric class 3	242	406	572	732	898	1060	1121	167	164
301 - 350	Fabric class 1	216	354	494	630	771	909	944	119	140
	Fabric class 2	239	398	558	713	880	1038	1096	157	158
	Fabric class 3	264	449	634	819	1007	1192	1272	189	186
351 - 400	Fabric class 1	235	387	540	692	850	1001	1050	132	157
	Fabric class 2	258	436	612	787	970	1146	1220	177	179
	Fabric class 3	286	491	701	907	1115	1321	1425	212	205
401 - 450	Fabric class 1	246	416	587	752	928	1091	1159	144	
	Fabric class 2	276	471	668	861	1062	1254	1347	195	
	Fabric class 3	307	537	767	992	1228	1455	1577	236	
451 - 500	Fabric class 1	264	447	633	813	1002	1184	1265	158	
	Fabric class 2	296	508	725	935	1152	1365	1476	214	
	Fabric class 3	332	581	832	1080	1334	1583	1577	259	

Screen covers

		Width		Height (m)																Price reduction if not ZIP
				0,61 - 0,80	0,81 - 1,00	1,01 - 1,20	1,21 - 1,40	1,41 - 1,60	1,61 - 1,80	1,81 - 2,00	2,01 - 2,20	2,21 - 2,40	2,41 - 2,60	2,61 - 2,80	2,81 - 3,00	3,01 - 3,20	3,21 - 3,40	3,41 - 3,60	3,61 - 3,80	
0,75-0,50	Sergé 600 / Soltis 86	86	92	99	107	114	123	130	136	143	154	160	165	174	182	191	196	204	-12	
	Sergé 1% / Soltis 92	89	96	103	111	119	129	135	141	151	160	165	172	182	188	198	204	212	-12	
100-0,76	Sergé 600 / Soltis 86	98	108	118	128	137	147	158	166	177	188	198	206	215	230	238	246	257	-16	
	Sergé 1% / Soltis 92	102	113	121	134	142	153	164	172	184	195	204	215	224	239	246	255	266	-16	
1,25-1,01	Sergé 600 / Soltis 86	111	121	135	147	161	172	184	198	208	221	236	246	259	270	283	296	307	-17	
	Sergé 1% / Soltis 92	114	126	140	153	166	177	191	204	216	230	244	255	268	281	294	306	320	-17	
1,50-1,26	Sergé 600 / Soltis 86	121	137	152	167	182	198	210	225	241	255	269	285	299	312	329	344	356	-19	
	Sergé 1% / Soltis 92	126	142	157	173	188	204	220	234	249	263	281	297	310	327	343	357	372	-19	
1,75-1,51	Sergé 600 / Soltis 86	135	152	170	186	204	220	240	255	272	290	306	323	343	355	376	391	410	-23	
	Sergé 1% / Soltis 92	141	157	176	194	210	227	248	263	283	300	318	336	354	371	391	407	426	-23	
2,00-1,76	Sergé 600 / Soltis 86	151	172	191	209	230	251	269	291	310	332	350	372	390	410	431	452	471	-25	
	Sergé 1% / Soltis 92	156	177	198	217	239	261	281	302	321	344	365	386	405	428	447	471	489	-25	
2,25-2,01	Sergé 600 / Soltis 86	164	184	208	228	252	276	299	319	343	363	387	410	431	455	477	498	521	-28	
	Sergé 1% / Soltis 92	170	193	216	238	262	286	310	332	354	377	403	426	448	474	495	519	543	-28	
2,50-2,26	Sergé 600 / Soltis 86	176	200	225	251	275	301	323	350	375	417	441	467	491	516	543	566	592	-30	
	Sergé 1% / Soltis 92	182	206	233	261	285	312	336	363	388	435	458	483	510	535	564	588	617	-30	
2,75-2,51	Sergé 600 / Soltis 86	187	216	241	268	298	323	352	380	407	450	479	507	533	562	588	616	642	-32	
	Sergé 1% / Soltis 92	195	224	248	276	307	336	365	393	420	467	498	528	554	584	612	639	669	-32	
3,00-2,76	Sergé 600 / Soltis 86	200	230	260	290	319	348	380	409	437	485	515	546	574	602	634	664	692	-34	
	Sergé 1% / Soltis 92	206	238	268	300	330	360	393	424	453	503	535	567	596	627	660	689	720	-34	
3,25-3,01	Sergé 600 / Soltis 86	216	246	279	312	344	372	408	439	472	522	554	585	619	649	682	713	746	-39	
	Sergé 1% / Soltis 92	224	255	290	323	356	387	423	455	490	543	575	606	643	676	709	742	776	-39	
3,50-3,26	Sergé 600 / Soltis 86	228	263	297	329	365	401	435	468	502	557	590	624	659	692	728	764	795	-41	
	Sergé 1% / Soltis 92	237	272	306	343	377	415	451	488	520	579	611	648	684	720	756	793	827	-41	
3,76-3,51	Sergé 600 / Soltis 86	239	276	313	350	388	424	460	498	535	590	627	664	701	737	773	811	848	-45	
	Sergé 1% / Soltis 92	246	284	327	365	403	439	477	517	554	611	651	689	728	767	804	843	881	-45	
4,00-3,75	Sergé 600 / Soltis 86	251	291	330	371	409	448	489	527	565	624	663	702	741	782	821	861	899	-47	
	Sergé 1% / Soltis 92	261	302	343	384	424	464	507	548	587	648	689	729	771	813	853	895	934	-47	
4,25-4,01	Sergé 600 / Soltis 86	263	306	348	390	433	475	517	560	602	663	704	747	790	833	875	917	961	-49	
	Sergé 1% / Soltis 92	272	315	360	405	451	493	537	583	627	689	731	777	822	868	910	954	999	-49	
4,50-4,26	Sergé 600 / Soltis 86	275	318	365	409	453	498	543	588	633	696	739	784	829	874	918	964	1008	-51	
	Sergé 1% / Soltis 92	283	328	377	424	472	515	562	608	657	721	766	814	860	907	954	999	1049	-51	
4,75-4,51	Sergé 600	284	334	380	426	474	520	567	616	663	727	773	821	869	914	963	1008	1055	-53	
5,00-4,76	Sergé 600	298	346	395	447	495	543	593	642	691	774	825	874	921	972	1020	1070	55	-55	
5,25-5,01	Sergé 600	308	360	413	464	515	566	618	669	721	806	856	911	959	1013	1062			-57	
5,50-5,26	Sergé 600	322	375	429	483	536	591	644	699	750	839	891	945	998	1055	1108			-60	
5,75-5,51	Sergé 600	334	388	446	502	558	613	669	724	782	873	927	982	1039	1094				-63	
6,00-5,76	Sergé 600	344	403	461	520	579	635	696	751	810	901	960	1019	1077					-66	

Screen covers

Important

- Prices valid for made to measure screens which are part of the Brustor collection
- Mandatory: always specify the diameter of the roller tube.

Features and benefits of screen fabrics (Sergé 600)

- With welded reinforcement strap on the sides.
- With bottom hem (fabric bar) of 3mm or 6mm and top Brustor hem (fabric bar) of 3 or 5 mm.
- Available width on stock: 1,9m, 2,5m & 2,7m (+ some references on 3,20m)
- When the total width exceeds the roll width, fabrics must be welded.
- More info: see Brustor screen sample booklet.

Features and benefits of Soltis & Sunworker fabrics

- With welded reinforcement strap of 15cm on the sides.
- With bottom hem of 3mm or 6mm and top hem of 3 or 5 mm.
- Width of Soltis on stock at Brustor: 1,77m (+ some references of 2,67m)
- When the total width exceeds the roll width, fabrics must be welded.

Surcharge for transparent PVC windows

Height window	1,21m	≤ 1,21m
Height window from the ground	0,90m	≠ 0,90m
Width screen up to 3m	142 net	285 net
Width screen from 3,01 to 4,00m	191 net	380 net
Width screen from 4,01 to 6,00m	331 net	567 net

 No warranty on folds formation and scratches.

Options with surcharge

- Surcharge Sergé 600 LUNAR / SOLAR on Soltis 86
£41/m²

Height (m)	Width	Width										Price reduction if not ZIP
		4,01 - 4,20	4,21 - 4,40	4,41 - 4,60	4,61 - 4,80	4,81 - 5,00	5,01 - 5,20	5,21 - 5,40	5,41 - 5,60	5,61 - 5,80	5,81 - 6,00	
0,75 - 0,50	Sergé 600 / Soltis 86	249	286	298	307	318	328	339	348	359	370	-12
	Sergé 1% / Soltis 92	260	272									-12
1,00 - 0,76	Sergé 600 / Soltis 86	301	343	355	368	381	393	407	418	431	443	-16
	Sergé 1% / Soltis 92	317	328									-16
1,25 - 1,01	Sergé 600 / Soltis 86	350	396	413	428	443	457	473	488	502	517	-17
	Sergé 1% / Soltis 92											-17
1,50 - 1,26	Sergé 600 / Soltis 86	399	452	471	487	504	521	538	557	573	591	-19
	Sergé 1% / Soltis 92	415	431									-19
1,75 - 1,51	Sergé 600 / Soltis 86	450	509	527	546	566	585	605	624	645	664	-23
	Sergé 1% / Soltis 92	468	487									-23
2,00 - 1,76	Sergé 600 / Soltis 86	538	563	585	607	628	651	672	696	717	740	-25
	Sergé 1% / Soltis 92	560	584									-25
2,25 - 2,01	Sergé 600 / Soltis 86	590	618	640	666	691	714	740	764	788	811	-28
	Sergé 1% / Soltis 92	613	638									-28
2,50 - 2,26	Sergé 600 / Soltis 86	655	671	699	726	751	779	806	833	858	886	-30
	Sergé 1% / Soltis 92	680	709									-30
2,75 - 2,51	Sergé 600 / Soltis 86	706	727	756	784	814	844	873	900	931	959	-32
	Sergé 1% / Soltis 92	734	764									-32
3,00 - 2,76	Sergé 600 / Soltis 86	754	781	813	846	876	907	939	970	1002	1033	-34
	Sergé 1% / Soltis 92	784	817									-34
3,25 - 3,01	Sergé 600 / Soltis 86	805	838	873	907	940	973	1007	1040			-39
	Sergé 1% / Soltis 92	836	871									-39
3,50 - 3,26	Sergé 600 / Soltis 86	856	894	929	965	1002	1039					-41
	Sergé 1% / Soltis 92	891	927									-41
3,76 - 3,51	Sergé 600 / Soltis 86	906	949	987	1025							-45
	Sergé 1% / Soltis 92	942	980									-45
4,00 - 3,75	Sergé 600 / Soltis 86	955	1002									-47
	Sergé 1% / Soltis 92	993	1035									-47
4,25 - 4,01	Sergé 600 / Soltis 86	1003	1045									-49
	Sergé 1% / Soltis 92	1044	1087									-49
4,50 - 4,26	Sergé 600 / Soltis 86	1053	1099									-51
	Sergé 1% / Soltis 92	1095	1143									-51

Paint set-up costs

Characteristics

ANO 20 µm similar to RAL 7035 grey
 On all the colours there is a little colour difference possible of 5%.
 Gloss grade = 70 pts, with a max deviation of 5 points possible.
 Surcharge for colour matching: **£115 net**

⚠ High gloss is not available due to being too scratch-sensitive!

Options

Colours that aren't in the Brustor preferred list **£172 + possible additional cost for expensive (Contact Brustor)**

Lacquer costs for spare parts

Description	Price
Set-up cost	£174
+ Profile / per running meter	£33
+ Foldable arm / per piece	£55
+ Small parts / piece	£33

Lacquer costs for combinations in the same colour

Description	Price
Screens: set-up cost of the lacquer colour for ≥ 3 and < 5 pieces	50% Set-up cost
Screens: set-up cost of the lacquer colour for ≥ 5 pieces	No set-up cost
6 screens with 1 B25 / B25 Elite / B25 Prestige	No set-up cost
3 screens with 1 B25 / B25 Elite / B25 Prestige	50% Set-up cost
1 B25 and 1 B25 Prestige	100% Set-up cost
1 B128 en 1 screen B1100	100% Set-up cost
1 B128 en 1 screen B1100	100% Set-up cost







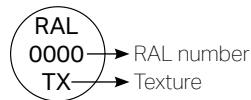

Examples lacquer costs

ZIP screens B1085 / B1100 / B1350 (1,8m width/ 1,5m height)

	RAL 9001 cream	RAL 6005 green 1 piece	RAL 6005 green 5 pieces	RAL 6005 green 10 pieces
Set-up costs	0	298	150	0
Lacquer costs	0	61	305	606
Total lacquer costs	0	303	425	606
Total lacquer costs / piece	0	303	84	61



Common colours

-  RAL 9016 Traffic white satin
-  RAL 9016 TX Traffic white texture
-  RAL 7016 TX Antracite grey texture
-  RAL 8019 Grey brown
-  RAL 9001 Cream white
-  RAL 9005 TX Jet black
-  ANO 20 µm Anodised 20 µm
-  RAL 7035 RAL 7035 satin (for castings of anodised awnings)
-  All other RAL colours in surcharge

RAL colours

Brustor Preferred List

Colour	Powder code	Type	Preferred supplier
R1000	14/15012	SATIN	TIGER
R1000MT	AE30011100020	MAT	AXALTA
R1001	14/10053	SATIN	TIGER
R1001MT	AE30011100120	MAT	AXALTA
R1002	14/20028	SATIN	TIGER
R1003	14/20029	SATIN	TIGER
R1003MT	29/21660	MAT	TIGER
R1004	14/20030	SATIN	TIGER
R1004MT	AE30011100420	MAT	AXALTA
R1005	14/20031	SATIN	TIGER
R1006	14/20032	SATIN	TIGER
R1007	14/20033	SATIN	TIGER
R1011	14/15005	SATIN	TIGER
R1011MT	AE300C1101120	MAT	AXALTA
R1012	14/20009	SATIN	TIGER
R1013	14/10021	SATIN	TIGER
R1013MT	AE30011101320	MAT	AXALTA
R1013ST	29/10933	TEXTURE	TIGER
R1014	14/15009	SATIN	TIGER
R1014MT	AE30011101420	MAT	AXALTA
R1015	14/15001	SATIN	TIGER
R1015MT	29/15200	MAT	TIGER
R1015ST	AE03051101520	TEXTURE	AXALTA
R1016	AE70011100225	SATIN	AXALTA
R1016MT	AE30011101620	MAT	AXALTA
R1017	14/20035	SATIN	TIGER
R1017MT	AE300C1101720	MAT	AXALTA
R1018	14/20007	SATIN	TIGER
R1018MT	29/20028	MAT	TIGER
R1018ST	AE03051101820	TEXTURE	AXALTA
R1019	14/15002	SATIN	TIGER
R1019MT	29/15370	MAT	TIGER
R1019ST	AE03051101920	TEXTURE	AXALTA
R1020	14/20006	SATIN	TIGER
R1020MT	AE30011102020	MAT	AXALTA
R1021	14/20021	SATIN	TIGER
R1021MT	29/21930	MAT	TIGER
R1023	14/20001	SATIN	TIGER
R1023MT	29/20723	MAT	TIGER
R1023ST	AE03051102320	TEXTURE	AXALTA
R1024	14/20022	SATIN	TIGER
R1024MT	AE300C1102420	MAT	AXALTA
R1027	14/20036	SATIN	TIGER
R1028	AE70011102820	SATIN	AXALTA
R1032	14/20037	SATIN	TIGER
R1032MT	AE30011103220	MAT	AXALTA
R1032ST	AE03051103220	TEXTURE	AXALTA
R1033	AE70011610125	SATIN	AXALTA
R1033MT	AE30011103320	MAT	AXALTA
R1034	14/20038	SATIN	TIGER
R1034MT	AE30011103420	MAT	AXALTA
R1037	14/20003	SATIN	TIGER
R2000	14/25017	SATIN	TIGER
R2001	14/25018	SATIN	TIGER
R2001MT	AE30012200120	MAT	AXALTA
R2002	14/25013	SATIN	TIGER
R2003	14/25019	SATIN	TIGER
R2003MT	AE300C2200320	MAT	AXALTA
R2004	014/25020	SATIN	TIGER
R2004MT	29/25016	MAT	TIGER
R2008	14/25021	SATIN	TIGER
R2009	14/25022	SATIN	TIGER
R2010	14/25015	SATIN	TIGER
R2012	AE70012201220	SATIN	AXALTA
R3000	14/30004	SATIN	TIGER
R3000MT	29/31170	MAT	TIGER
R3000ST	029/30702	TEXTURE	TIGER
R3001	14/30021	SATIN	TIGER
R3001MT	29/30009	MAT	TIGER
R3002	14/30005	SATIN	TIGER
R3003	14/30020	SATIN	TIGER
R3003MT	29/30022	MAT	TIGER
R3004	14/30014	SATIN	TIGER
R3004MT	29/31320	MAT	TIGER
R3004ST	29/30706	TEXTURE	TIGER
R3005	14/30006	SATIN	TIGER
R3005MT	29/31850	MAT	TIGER
R3005ST	AE03053300520	TEXTURE	AXALTA
R3007	AE70013975125	SATIN	AXALTA
R3007MT	AE30013300720	MAT	AXALTA
R3007ST	AE03053300720	TEXTURE	AXALTA

Colour	Powder code	Type	Preferred supplier
R3009	AE70018400225	SATIN	AXALTA
R3009MT	AE30013300920	MAT	AXALTA
R3011	14/30035	SATIN	TIGER
R3011MT	AE30013301120	MAT	AXALTA
R3012	AE70013260125	SATIN	AXALTA
R3012MT	AE30013301220	MAT	AXALTA
R3013	14/30026	SATIN	TIGER
R3013MT	AE300C3301320	MAT	AXALTA
R3014	AE70013301420	SATIN	AXALTA
R3014MT	AE30013301420	MAT	AXALTA
R3015	14/30037	SATIN	TIGER
R3016	14/30044	SATIN	TIGER
R3016MT	AE30013301620	MAT	AXALTA
R3017	14/30081	SATIN	TIGER
R3017MT	AE30013301720	MAT	AXALTA
R3018	14/30028	SATIN	TIGER
R3018MT	AE300C3301820	MAT	AXALTA
R3020	14/30024	SATIN	TIGER
R3020MT	29/32090	MAT	TIGER
R3020ST	AE03053302020	TEXTURE	AXALTA
R3022	AE70013160125	SATIN	AXALTA
R3027	14/30047	SATIN	TIGER
R3027MT	AE30013302720	MAT	AXALTA
R3028	14/30010	SATIN	TIGER
R3031	AE70013230425	SATIN	AXALTA
R3031MT	AE30013303120	MAT	AXALTA
R4001	14/40077	SATIN	TIGER
R4001MT	AE30013400120	MAT	AXALTA
R4002	14/30058	SATIN	TIGER
R4003	14/30061	SATIN	TIGER
R4004	14/30059	SATIN	TIGER
R4005	14/30052	SATIN	TIGER
R4006	14/30053	SATIN	TIGER
R4006MT	AE300C3400620	MAT	AXALTA
R4007	14/30054	SATIN	TIGER
R4007MT	AE300C3400720	MAT	AXALTA
R4008	14/30055	SATIN	TIGER
R4008MT	AE30013400820	MAT	AXALTA
R4009	14/30056	SATIN	TIGER
R4009MT	AE300C3400920	MAT	AXALTA
R4010	14/30057	SATIN	TIGER
R5000	AE70015500020	SATIN	AXALTA
R5000MT	AE30015500020	MAT	AXALTA
R5001	AE70015820125	SATIN	AXALTA
R5001MT	AE300C5500120	MAT	AXALTA
R5002	14/40009	SATIN	TIGER
R5002MT	29/46170	MAT	TIGER
R5002ST	AE03055500220	TEXTURE	AXALTA
R5003	14/40028	SATIN	TIGER
R5003MT	AE300C5500320	MAT	AXALTA
R5003ST	029/41425	TEXTURE	TIGER
R5004	AE70015970125	SATIN	AXALTA
R5004MT	29/42160	MAT	TIGER
R5005	14/40029	SATIN	TIGER
R5005MT	29/47080	MAT	TIGER
R5005ST	029/41427	TEXTURE	TIGER
R5007	14/40024	SATIN	TIGER
R5007MT	AE30015500720	MAT	AXALTA
R5008	14/40010	SATIN	TIGER
R5008MT	AE300C5500820	MAT	AXALTA
R5008ST	29/41112	TEXTURE	TIGER
R5009	14/40066	SATIN	TIGER
R5009MT	AE30015500920	MAT	AXALTA
R5010	14/40011	SATIN	TIGER
R5010MT	29/41180	MAT	TIGER
R5010ST	AE03055501020	TEXTURE	AXALTA
R5011	14/40014	SATIN	TIGER
R5011MT	29/41930	MAT	TIGER
R5011ST	AE03055501120	TEXTURE	AXALTA
R5012	AE70015310325	SATIN	AXALTA
R5012MT	AE30015501220	MAT	AXALTA
R5013	14/40012	SATIN	TIGER
R5013MT	29/49940	MAT	TIGER
R5013ST	AE03055501320	TEXTURE	AXALTA
R5014	AE70015270125	SATIN	AXALTA
R5014MT	AE300C5501420	MAT	AXALTA
R5014ST	AE03055501420	TEXTURE	AXALTA
R5015	14/40030	SATIN	TIGER
R5015MT	AE30015501520	MAT	AXALTA
R5015ST	AE03055501520	TEXTURE	AXALTA
R5017	14/40018	SATIN	TIGER



Colour	Powder code	Type	Preferred supplier
R5017MT	AE30015501720	MAT	AXALTA
R5018	14/40032	SATIN	TIGER
R5018MT	AE30015501820	MAT	AXALTA
R5019	14/40087	SATIN	TIGER
R5020	14/40088	SATIN	TIGER
R5020MT	AE30015502020	MAT	AXALTA
R5021	14/40093	SATIN	TIGER
R5021MT	AE30015502120	MAT	AXALTA
R5022	14/40055	SATIN	TIGER
R5022MT	29/45730	MAT	TIGER
R5023	14/40031	SATIN	TIGER
R5023MT	29/41870	MAT	TIGER
R5024	14/40089	SATIN	TIGER
R5024MT	29/45500	MAT	TIGER
R6000	14/50062	SATIN	TIGER
R6000MT	AE30016600020	MAT	AXALTA
R6001	14/50038	SATIN	TIGER
R6001MT	AE30006600120	MAT	AXALTA
R6002	14/50019	SATIN	TIGER
R6002MT	29/50420	MAT	TIGER
R6003	AE70016380125	SATIN	AXALTA
R6003MT	AE30006600320	MAT	AXALTA
R6004	14/50030	SATIN	TIGER
R6004MT	29/56180	MAT	TIGER
R6005	14/50012	SATIN	TIGER
R6005MT	29/53160	MAT	TIGER
R6005ST	029/50321	TEXTURE	TIGER
R6006	14/50064	SATIN	TIGER
R6007	14/50043	SATIN	TIGER
R6007MT	AE30016600720	MAT	AXALTA
R6007ST	AE03056600720	TEXTURE	AXALTA
R6008	14/50065	SATIN	TIGER
R6008MT	AE30016600820	MAT	AXALTA
R6009	14/50016	SATIN	TIGER
R6009MT	AE30016600920	MAT	AXALTA
R6009ST	29/50800	TEXTURE	TIGER
R6010	14/50031	SATIN	TIGER
R6010MT	AE30016601020	MAT	AXALTA
R6011	AE70016270225	SATIN	AXALTA
R6011MT	AE30006601120	MAT	AXALTA
R6011ST	029/51342	TEXTURE	TIGER
R6012	14/50015	SATIN	TIGER
R6012MT	29/52520	MAT	TIGER
R6012ST	AE03056601220	TEXTURE	AXALTA
R6013	14/50066	SATIN	TIGER
R6014	14/50067	SATIN	TIGER
R6014MT	AE30016601420	MAT	AXALTA
R6015	14/50068	SATIN	TIGER
R6015MT	AE30016601520	MAT	AXALTA
R6016	14/50069	SATIN	TIGER
R6016MT	AE30016601620	MAT	AXALTA
R6017	14/50051	SATIN	TIGER
R6017MT	AE30006601720	MAT	AXALTA
R6017ST	AE03056601720	TEXTURE	AXALTA
R6018	14/50086	SATIN	TIGER
R6018MT	AE30006601820	MAT	AXALTA
R6019	AE70016160325	SATIN	AXALTA
R6019MT	AE30006601920	MAT	AXALTA
R6019ST	29/51343	TEXTURE	TIGER
R6020	14/50071	SATIN	TIGER
R6020MT	AE30016602020	MAT	AXALTA
R6021	14/50072	SATIN	TIGER
R6021MT	29/63690	MAT	TIGER
R6021ST	29/51344	TEXTURE	TIGER
R6022	14/50073	SATIN	TIGER
R6024	14/50074	SATIN	TIGER
R6024MT	AE30016602420	MAT	AXALTA
R6025	14/50075	SATIN	TIGER
R6025MT	AE30016602520	MAT	AXALTA
R6026	14/50076	SATIN	TIGER
R6026MT	AE30016602620	MAT	AXALTA
R6027	14/50077	SATIN	TIGER
R6028	14/50078	SATIN	TIGER
R6028MT	29/54270	MAT	TIGER
R6029	14/50018	SATIN	TIGER
R6029MT	29/54460	MAT	TIGER
R6031MT	AE30016870625	MAT	AXALTA
R6032	14/50079	SATIN	TIGER
R6032MT	29/53370	MAT	TIGER
R6033	14/50080	SATIN	TIGER
R6033MT	AE30016603320	MAT	AXALTA
R6034	14/50054	SATIN	TIGER
R6037	AE70016603720	SATIN	AXALTA
R7000	14/70063	SATIN	TIGER
R7001	14/70034	SATIN	TIGER
R7001MT	AE30017700120	MAT	AXALTA

Colour	Powder code	Type	Preferred supplier
R7001ST	AE03057700120	TEXTURE	AXALTA
R7002	14/70131	SATIN	TIGER
R7002MT	29/70478	MAT	TIGER
R7003	14/70132	SATIN	TIGER
R7003MT	AE30017700320	MAT	AXALTA
R7003ST	AE03057700320	TEXTURE	AXALTA
R7004	14/70064	SATIN	TIGER
R7004MT	29/70344	MAT	TIGER
R7004ST	029/73205	TEXTURE	TIGER
R7005	14/70074	SATIN	TIGER
R7005MT	29/70136	MAT	TIGER
R7005ST	AE03057700520	TEXTURE	AXALTA
R7006	14/70133	SATIN	TIGER
R7006MT	AE30017700620	MAT	AXALTA
R7006ST	29/73223	TEXTURE	TIGER
R7008	14/70134	SATIN	TIGER
R7008MT	AE30017700820	MAT	AXALTA
R7009	14/70136	SATIN	TIGER
R7009MT	AE30017700920	MAT	AXALTA
R7009ST	AE03057700920	TEXTURE	AXALTA
R7010	14/70087	SATIN	TIGER
R7010MT	AE30017701020	MAT	AXALTA
R7010ST	AE03057701020	TEXTURE	AXALTA
R7011	14/70030	SATIN	TIGER
R7011MT	AE30007701120	MAT	AXALTA
R7011ST	AE03057701120	TEXTURE	AXALTA
R7012	14/70037	SATIN	TIGER
R7012MT	29/79660	MAT	TIGER
R7012ST	AE03057701220	TEXTURE	AXALTA
R7013	14/70137	SATIN	TIGER
R7013MT	AE30007701320	MAT	AXALTA
R7013ST	AE03057701320	TEXTURE	AXALTA
R7015	14/70018	SATIN	TIGER
R7015MT	AE30017701520	MAT	AXALTA
R7015ST	AE03057701520	TEXTURE	AXALTA
R7016	14/70019	SATIN	TIGER
R7016MT	AE30017701620	MAT	AXALTA
R7016ST	AE03057701620	TEXTURE	AXALTA
R7021	14/70065	SATIN	TIGER
R7021MT	AE30017702120	MAT	AXALTA
R7021ST	29/71263	TEXTURE	TIGER
R7022	14/70040	SATIN	TIGER
R7022MT	AE30017702220	MAT	AXALTA
R7022ST	29/71740	TEXTURE	TIGER
R7023	14/70138	SATIN	TIGER
R7023MT	AE30017702320	MAT	AXALTA
R7023ST	29/72362	TEXTURE	TIGER
R7024	14/70020	SATIN	TIGER
R7024MT	29/70029	MAT	TIGER
R7024ST	029/71795	TEXTURE	TIGER
R7026	14/70115	SATIN	TIGER
R7026MT	AE30017702620	MAT	AXALTA
R7030	14/70021	SATIN	TIGER
R7030MT	29/79340	MAT	TIGER
R7030ST	29/71715	TEXTURE	TIGER
R7031	14/70075	SATIN	TIGER
R7031MT	29/79690	MAT	TIGER
R7031ST	AE03057703120	TEXTURE	AXALTA
R7032	14/70022	SATIN	TIGER
R7032MT	29/70035	MAT	TIGER
R7032ST	29/72073	TEXTURE	TIGER
R7033	14/70139	SATIN	TIGER
R7033MT	AE30017703320	MAT	AXALTA
R7034	14/70102	SATIN	TIGER
R7034ST	029/71666	TEXTURE	TIGER
R7035	14/70023	SATIN	TIGER
R7035MT	29/72160	MAT	TIGER
R7035ST	29/72111	TEXTURE	TIGER
R7036	14/70066	SATIN	TIGER
R7036MT	AE30017703620	MAT	AXALTA
R7036ST	29/72859	TEXTURE	TIGER
R7037	14/70024	SATIN	TIGER
R7037MT	AE30017703720	MAT	AXALTA
R7037ST	29/72184	TEXTURE	TIGER
R7038	14/70025	SATIN	TIGER
R7038MT	29/70276	MAT	TIGER
R7038ST	29/73229	TEXTURE	TIGER
R7039	14/70123	SATIN	TIGER
R7039MT	29/73213	MAT	TIGER
R7039ST	AE03057703920	TEXTURE	AXALTA
R7040	14/70026	SATIN	TIGER
R7040MT	29/73330	MAT	TIGER
R7040ST	29/72710	TEXTURE	TIGER
R7042	14/70117	SATIN	TIGER
R7042MT	AE30017704220	MAT	AXALTA
R7042ST	029/72089	TEXTURE	TIGER

Colour	Powder code	Type	Preferred supplier
R7043	14/70091	SATIN	TIGER
R7043MT	AE300C7704320	MAT	AXALTA
R7043ST	29/73220	TEXTURE	TIGER
R7044	14/70067	SATIN	TIGER
R7044MT	AE30017704420	MAT	AXALTA
R7044ST	29/71718	TEXTURE	TIGER
R7045	14/70110	SATIN	TIGER
R7045MT	29/70191	MAT	TIGER
R7045ST	029/72360	TEXTURE	TIGER
R7046	14/70038	SATIN	TIGER
R7046MT	29/70194	MAT	TIGER
R7046ST	29/73210	TEXTURE	TIGER
R7047	14/70039	SATIN	TIGER
R7047MT	29/70624	MAT	TIGER
R7047ST	29/73227	TEXTURE	TIGER
R8000	14/60064	SATIN	TIGER
R8001	14/60032	SATIN	TIGER
R8001MT	29/60745	MAT	TIGER
R8001ST	29/61332	TEXTURE	TIGER
R8002	14/60065	SATIN	TIGER
R8002MT	AE30018800220	MAT	AXALTA
R8003	14/60033	SATIN	TIGER
R8003MT	29/63730	MAT	TIGER
R8003ST	29/60898	TEXTURE	TIGER
R8004	14/60057	SATIN	TIGER
R8004MT	29/69270	MAT	TIGER
R8004ST	029/60455	TEXTURE	TIGER
R8007	14/60018	SATIN	TIGER
R8007MT	AE30018800720	MAT	AXALTA
R8007ST	029/61348	TEXTURE	TIGER
R8008	14/60066	SATIN	TIGER
R8008MT	AE30018800820	MAT	AXALTA
R8011	14/60026	SATIN	TIGER
R8011MT	29/63100	MAT	TIGER
R8011ST	29/61344	TEXTURE	TIGER
R8012	14/60067	SATIN	TIGER
R8012MT	AE30018801220	MAT	AXALTA
R8012ST	029/61340	TEXTURE	TIGER
R8014	14/60008	SATIN	TIGER
R8014MT	AE30018801420	MAT	AXALTA
R8014ST	29/60488	TEXTURE	TIGER
R8015	14/60017	SATIN	TIGER
R8015MT	29/61470	MAT	TIGER
R8016	14/60027	SATIN	TIGER
R8016MT	AE300C8801620	MAT	AXALTA
R8016ST	29/61311	TEXTURE	TIGER
R8017	14/60009	SATIN	TIGER
R8017MT	AE300C8801720	MAT	AXALTA
R8017ST	29/61333	TEXTURE	TIGER
R8019	AE70058805822	SATIN	AXALTA
R8019MT	29/62060	MAT	TIGER
R8019ST	AE03058801920	TEXTURE	AXALTA
R8022	14/60020	SATIN	TIGER
R8022MT	AE30018802220	MAT	AXALTA
R8022ST	29/60861	TEXTURE	TIGER
R8023	14/60034	SATIN	TIGER
R8023MT	29/62950	MAT	TIGER
R8024	AE70018100425	SATIN	AXALTA
R8025	14/60069	SATIN	TIGER
R8025MT	AE30018802520	MAT	AXALTA
R8027	AE70018500125	SATIN	AXALTA
R8028	14/60035	SATIN	TIGER
R8028MT	29/63930	MAT	TIGER
R8028ST	AE03058802820	TEXTURE	AXALTA
R9001	AE70019900120	SATIN	AXALTA
R9001MT	AE300C9900120	MAT	AXALTA
R9001ST	29/10553	TEXTURE	TIGER
R9002	14/10022	SATIN	TIGER
R9002MT	29/71750	MAT	TIGER
R9002ST	29/11065	TEXTURE	TIGER
R9003	14/10023	SATIN	TIGER
R9003MT	AE300C9900320	MAT	AXALTA
R9003ST	29/11468	TEXTURE	TIGER
R9004	14/80022	SATIN	TIGER
R9004MT	29/80730	MAT	TIGER
R9004ST	AE03054900420	TEXTURE	AXALTA
R9005	14/80008	SATIN	TIGER
R9005MT	29/80430	MAT	TIGER
R9005ST	SN305G	TEXTURE	AKZO NOBEL
R9006MT	AE30217900620	MAT	AXALTA
R9006ST	AE03257900620	TEXTURE	AXALTA
R9007MT	AE30217900720	MAT	AXALTA
R9007ST	AE03257900720	TEXTURE	AXALTA
R9008ST	AE03257900820	TEXTURE	AXALTA
R9010	14/10025	SATIN	TIGER
R9010MT	29/10470	MAT	TIGER

Colour	Powder code	Type	Preferred supplier
R9010ST	AE03059901020	TEXTURE	AXALTA
R9011	14/80009	SATIN	TIGER
R9011MT	29/81930	MAT	TIGER
R9011ST	029/80527	TEXTURE	TIGER
R9016	AE80019901620	SATIN	AXALTA
R9016MT	AE300C9901620	MAT	AXALTA
R9016ST	AE03059901620	TEXTURE	AXALTA
R9017	14/80024	SATIN	TIGER
R9017MT	29/81710	MAT	TIGER
R9017ST	29/88001	TEXTURE	TIGER
R9018	14/10093	SATIN	TIGER
R9018MT	AE30019901820	MAT	AXALTA
R9021	AE70014980325	SATIN	AXALTA

DB703

Colour	Powder code	Type	Preferred supplier
DB703	5807E71386S10	SATIN	IGP
DB703ST	029/80077	TEXTURE	TIGER
DB703MT	029/82030	MAT	TIGER

Specials

Colour	Powder code	Type	Preferred supplier
9016HG	AE80019901620	HIGH GLOSS	AXALTA
9007ST	AE03257900720	TEXTURE	AXALTA
JANUARY3	AE03217049320	TEXTURE	AXALTA
noir2100	YW359F	TEXTURE	AKZO NOBEL
029/60740	29/60740	TEXTURE	TIGER
029/60674	029/60674	TEXTURE	TIGER
51 (REYNAERS R9010)	AE90019148021	SATIN	AXALTA
AE70011101	AE70011101520	SATIN	AXALTA
029/80081	029/80081	TEXTURE	TIGER
YW355F	YW355F	TEXTURE	AKZO NOBEL
581ME71319	581ME71319A10	TEXTURE	IGP
R8019MST	29/60674	TEXTURE	TIGER
R9006	AE80157900620	80 % HIGH GLOSS	AXALTA
R9007	AE80157900720	75 % HIGH GLOSS	AXALTA

Standard profiles

 Ordering profiles can affect the delivery time!
 With special paint, an additional extended delivery period must be taken into account

Standard aluminum tubes, lacquered in a standard colour, per 6 meter

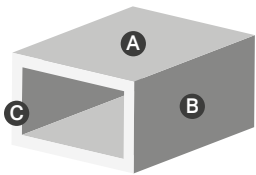

Dimensions (A x B x C)	£ / 7 m	Art. nr
30 x 20 x 2	171	5002844
30 x 30 x 2	183	5002845
40 x 20 x 2	183	5002846
40 x 40 x 2	207	5002847
50 x 25 x 2	202	5002848
50 x 50 x 2	231	5002849
60 x 30 x 2	220	5002850
60 x 60 x 2	257	5002871
70 x 20 x 2	220	5002872
70 x 70 x 2	281	5002873
80 x 40 x 2	257	5002874
80 x 80 x 3	397	5002875
100 x 20 x 2	257	5002876
100 x 50 x 2	293	5002877
120 x 40 x 2,5	352	5002878
150 x 50 x 3	470	5002879
200 x 50 x 4	706	5002880

Aluminum L-profiles, lacquered in a standard colour, per 6 meter

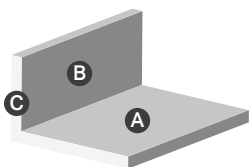

Dimensions (A x B x C)	£ / 7 m	Art. nr
15 x 15 x 2	131	5002881
20 x 20 x 2	138	5002882
25 x 25 x 2	143	5002883
30 x 30 x 2	151	5002884
40 x 20 x 2	151	5002885
40 x 40 x 2	161	5002886
50 x 20 x 2	157	5002887
50 x 50 x 2	175	5002888
60 x 60 x 2	187	5002889
70 x 20 x 2	168	5002890
100 x 20 x 2	187	5002891
120 x 20 x 2,5	219	5002892

Minimal dimensions awnings

Projection	Width	B20	B25 B27	B24 B25 B27 Elite	B24 B25 B27 Prestige	B35 Elite	B35 Prestige	B38 Elite	B38 Prestige	B50	B50 S	B50 XL Elite	
2 arms B	1,50m	1,96m	2,03m	2,05m		2,05m		2,05m		1,78m	1,90m	1,91m	
	2,00m	2,48m	2,55m	2,57m		2,57m		2,57m		2,30m	2,42m	2,43m	
	2,50m	2,93m	2,98m	3,00m		3,00m		3,00m		2,73m	2,85m	2,86m	
	3,00m	3,40m	3,46m	3,49m	3,49m	3,50m	3,53m	3,50m	3,53m	3,21m	3,33m	3,34m	
	3,50m			4,00m	4,03m	4,24m	4,24m	4,24m	4,24m			3,85m	
	3,75m			4,25m	4,25m								
	4,00m					4,74m	4,74m						
	built-in led control unit		+ 0,30m	+ 0,30m	+ 0,30m	+ 0,30m	+ 0,30m	+ 0,30m	+ 0,30m	+ 0,30m			
	Eolis 3D built-in A		+ 0,16m	+ 0,16m	+ 0,16m	+ 0,16m	+ 0,16m	+ 0,16m	+ 0,16m	+ 0,16m			
3 arms B	1,50m		3,05m	3,05m		3,05m		3,05m					
	2,00m		3,85m	3,85m		3,85m		3,85m					
	2,50m		4,48m	4,48m		4,48m		4,48m					
	3,00m		5,17m	5,25m	5,25m	5,49m	5,49m	5,49m	5,49m				
	3,50m			6,00m	6,00m	6,25m	6,25m		6,00m				
	3,75m			6,39m	6,39m								
	4,00m					7,00m	7,00m						
	built-in led control unit		+ 0,30m	+ 0,30m	+ 0,30m	+ 0,30m	+ 0,30m	+ 0,30m	+ 0,30m	+ 0,30m			
	Eolis 3D built-in A		+ 0,16m	+ 0,16m	+ 0,16m	+ 0,16m	+ 0,16m	+ 0,16m	+ 0,16m	+ 0,16m			
4 arms B	1,50m		4,50m	4,50m		4,50m		4,50m					
	2,00m		5,60m	5,60m		5,60m		5,60m					
	2,50m		6,50m	6,50m		6,50m							
	3,00m		7,32m	7,48m	7,48m	7,42m	7,42m						
	3,50m			8,48m	8,48m	8,60m D	8,60m D						
	3,75m			8,93m	8,93m								
	4,00m					9,60m D	9,60m D						
	built-in led control unit		+ 0,60m	+ 0,60m	+ 0,60m	+ 0,60m	+ 0,60m	+ 0,60m	+ 0,60m				
	Eolis 3D built-in A		+ 0,16m	+ 0,16m	+ 0,16m	+ 0,16m	+ 0,16m	+ 0,16m	+ 0,16m				
6 arms B	1,50m		7,10m	7,10m		7,10m							
	2,00m		8,60m	8,60m		8,60m							
	2,50m		9,90m	9,90m		9,90m							
	3,00m		10,82m	10,82m	10,84m	11,00m	11,10m						
	3,50m			12,35m	12,44m	12,53m	12,62m						
	3,75m												
	4,00m												
	built-in led control unit		+ 0,60m	+ 0,60m	+ 0,60m	+ 0,60m	+ 0,60m	+ 0,60m	+ 0,60m				
	Eolis 3D built-in A		+ 0,16m	+ 0,16m	+ 0,16m	+ 0,16m	+ 0,16m	+ 0,16m	+ 0,16m				

A Only if Eolis 3D is ordered at the same time **B** Coupled awnings without cover joint or with a fabric in 1 part (B35 Elite & B35 Prestige): min. dimensions - 320mm **D** If NHK motor or Somfy Sunea CSI RTS, then minimum size is + 50mm.

Prostor Parasols



		
UNO		
Grey (RAL 9007)	Black (RAL 9005) White (RAL 9016)	Copper

PROSTOR P6

1. CHOICE TYPE

FRAME + STD FABRIC* + POLE	SQR □2,5 m	£ 1321	£ 1343	£ 1580
	SQR XL □3,0 m	£ 1541	£ 1567	£ 1816
	RND Ø3,5 m	£ 1365	£ 1392	£ 1628
	RND XL Ø4,2 m	£ 1606	£ 1632	£ 1890

2. ACCESSORIES

GLOW LED LIGHT		GLOW FOR NET SUPPLY	£ 259
		GLOW INCL. BATTERY KIT	£ 346

RGB LED LIGHT (MODEL <2024)		RGB FOR NET SUPPLY	£ 455
--------------------------------	---	--------------------	-------

SURCHARGE PREMIUM FABRIC	SQR □2,5 m	£ 53
	SQR XL □3,0 m	£ 61
	RND Ø3,5 m	£ 71
	RND XL Ø4,2 m	£ 83

SURCHARGE PRE-MOUNTING FABRIC	ALL DIMENSIONS	£ 31
----------------------------------	----------------	------

PROTECTION COVER	WALL	£ 150
	WALL XL	£ 180
	SQR □2,5 m / RND Ø3,5 m	£ 176
	SQR XL □3,0 m / RND XL Ø4,2 m	£ 202

RAINGUTTER	SQR □2,5 m	
	SQR XL □3,0 m	
	SURCHARGE PREMIUM	

HEATING**	1500W	£ 293
-----------	-------	-------

SOCKETS**	SINGLE	£ 49
	DOUBLE	£ 71

3. FIXATION

FLOORPLATE***	50 cm × 70 cm	
	70 cm × 70 cm	

STEEL BASE*** + ALU COVER**	80 cm × 80 cm × 12 cm	
	100 cm × 100 cm × 10 cm	
	OPTION + WHEELS	£ 105

GROUNDANCHOR***	SUITABLE FOR ALL MODELS	
-----------------	-------------------------	--

WALL BRACKET****	SQR □2,5 m / SQR XL □3,0 m	£ 132
------------------	----------------------------	-------

- * Fabric not fitted.
- ** Available in Grey, Black and White.
- *** Incl. pole support, incl. top & bottom cover.
- **** Incl. top cover. Available in Grey, Black and White.



PRICE LIST P6

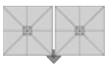
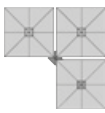
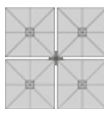

								
DUO			TRIO			QUATTRO		
Grey (RAL 9007)	Black (RAL 9005) White (RAL 9016)	Copper	Grey (RAL 9007)	Black (RAL 9005) White (RAL 9016)	Copper	Grey (RAL 9007)	Black (RAL 9005) White (RAL 9016)	Copper
£ 2328	£ 2363	£ 2765	£ 3334	£ 3383	£ 3952	£ 4340	£ 4402	£5137
£ 2765	£ 2809	£ 3238	£ 3990	£ 4051	£ 4660	£ 5216	£ 5295	£ 6082
£ 2415	£ 2460	£ 2862						
£ 2896	£ 2940	£ 3387						
£ 438			£ 618			£ 796		
£ 630			£ 915			£ 1200		
£ 574			£ 691			£ 810		
£ 105			£ 158			£ 210		
£ 123			£ 184			£ 245		
£ 140								
£ 166								
£ 61			£ 93			£ 123		
£ 298								
£ 360								
£ 210			£ 263					
£ 250			£ 320					
£ 67			£ 132			£ 263		
£ 71			£ 140			£ 281		
£ 10			£ 18			£ 36		
£ 586			£ 880			£ 1173		
			£97					
£ 71						£ 140		
£ 451								
£ 503								
£ 832								
£ 911								
£ 263								
£ 132								



PROSTOR P7

1. CHOICE TYPE	FRAME + STD FABRIC* + POLE	SQR □2,5 m
		SQR XL □3,0 m
		RND Ø3,5 m
		RND XL Ø4,2 m
2. ACCESSORIES	GLOW LED LIGHT 	GLOW FOR NET SUPPLY
		GLOW INCL. BATTERY KIT
	RGB LED LIGHT (MODEL <2024) 	RGB FOR NET SUPPLY
	SURCHARGE PREMIUM FABRIC	SQR □2,5 m
		SQR XL □3,0 m
		RND Ø3,5 m
		RND XL Ø4,2 m
	SURCHARGE PRE-MOUNTING FABRIC	EXTRA SURCHARGE
	PROTECTION COVER	WALL
WALL XL		
SQR □2,5 m / RND Ø3,5 m		
SQR XL □3,0 m / RND XL Ø4,2 m		
RAINGUTTER	SQR □2,5 m	
	SQR XL □3,0 m	
	SURCHARGE PREMIUM	
HEATING**	1500W	
SOCKETS**	SINGLE	
3. FIXATION	FLOORPLATE***	50 cm × 70 cm
		70 cm × 70 cm
	STEEL BASE*** + ALU COVER**	80 cm × 80 cm × 12 cm
		100 cm × 100 cm × 10 cm
		OPTION + WHEELS
GROUNDANCHOR***	SUITABLE FOR ALL MODELS	
TURNABLE WALL BRACKET****	SQR □2,5m / SQR XL □3,0 m / RND Ø3,5 m / RND XL Ø4,2 m	

- * Fabric not fitted.
- ** Available in Grey, Black and White.
- *** Incl. pole support, incl. top & bottom cover.
- **** Incl. top cover.

PRICE LIST P7



 UNO		
Grey (RAL 9007)	Black (RAL 9005)	Copper
	White (RAL 9016)	
£ 1252	£ 1274	£ 1515
£ 1470	£ 1497	£ 1751
£ 1295	£ 1321	£ 1563
£ 1537	£ 1563	£ 1825
£ 259		
£ 346		
£ 455		
£ 53		
£ 61		
£ 71		
£ 83		
£ 31		
£ 150		
£ 180		
£ 176		
£ 202		
£ 67		
£ 71		
£ 10		
£ 293		
£ 49		
£ 451		
£ 503		
£ 832		
£ 911		
£ 105		
£ 271		
£ 172		

Prostor Parasols

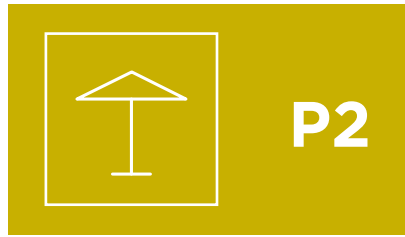
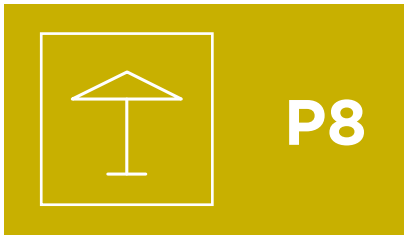

				Grey (RAL 9007)	Black (RAL 9005)
PROSTOR P8					
1. CHOICE TYPE	FRAME + STD FABRIC* + POLE	SQR □4,0 m		£ 2100	£ 2276
	FRAME + STD FABRIC* +  + POLE	SQR □4,0 m		£ 2910	£ 3085
	SURCHARGE PREMIUM FABRIC	SQR □4,0 m		£ 53	
2. ACCESSORIES	PROTECTION COVER	SQR □4,0 m		£ 451	
	RAINGUTTER	SQR □4,0 m		£ 83	
		SURCHARGE PREMIUM		£ 10	
	HEATER 1500W (EACH)**	SET 2 PCS		£ 709	
		SET 4 PCS		£ 1418	
SOCKETS**	SET 2 PCS		£ 150		
	SET 4 PCS		£ 298		
3. FIXATION	FLOORPLATE***	70 cm × 70 cm		£ 503	
	STEEL BASE*** + ALU COVER**	80 cm × 80 cm × 12 cm		£ 832	
		100 cm × 100 cm × 10 cm		£ 911	
		OPTION + WHEELS		£ 105	
GROUNDANCHOR***			£ 263		

* Fabric fitted.
 ** Available in Grey and Black.
 *** Incl. pole support & bottom cover.

		 Anodised aluminium	
FRAME + FABRIC + POLE	PARASOL Ø2,7 M + CONCRETE BASE WITH TELESCOPIC POLE		£ 355
ACCESSORIES	POLYESTER PROTECTION COVER		INCLUSIVE
FIXATION	BLACK CONCRETE BASE (45 × 45 cm) WITH TELESCOPIC POLE		INCLUSIVE
	OPTION SWIVEL WHEELS WITH BRAKE (PER 4 PCS)		£ 57

Prostor Parasols





P3



P4



		
PROSTOR P3		Anodised aluminium
FRAME + FABRIC + ARM	PARASOL Ø2,7 m + TELESCOPIC ARM + WALL BRACKET	£ 665
ACCESSORIES	POLYESTER PROTECTION COVER	INCLUSIVE
FIXATION	WALL BRACKET	INCLUSIVE

		
PROSTOR P4		Anodised aluminium
FRAME + FABRIC + ARM	PARASOL Ø2,7 m + TELESCOPIC ARM + WALL BRACKET	£ 788
ACCESSORIES	POLYESTER PROTECTION COVER	INCLUSIVE
FIXATION	WALL BRACKET	INCLUSIVE

CUSTOM MADE PARASOL OR SPECIAL REQUEST

At Prostor, we understand the importance of personalization and are pleased to offer tailored solutions to meet your specific needs, especially for projects where scale allows us to provide the best possible support.

Here are the available customization options for our parasols:



FABRIC COLOR OF CANOPY

Choose from a wide range of canopy colors of our trusted suppliers to match your preferences.



SPECIAL CANOPY FEATURES

Fire-retardant fabric (e.g., Firemaster) for enhanced safety.



FRAME/ POLE COLOR

Customize in any RAL color your P6, P7 or P8 model for a perfect match with your setting.



VALANCES

Add valances to square models P6, P7 and P8. Valances can be easily zipped on the canopy using the pre-fitted zippers.



LOGO PRINTING

Personalize the canopy or valances with a logo using thermofoil full-color printing.

Note: Please be aware that personalized parasols will have slightly extended delivery terms.

Contact our team or your direct contact to receive a personalized offer.

Prostor Parasols

UPGRADE YOUR PARASOL EXPERIENCE FEATURES

Our parasols are more than just a shade solution, they are a blend of elegance, innovation, and functionality. Here are the available upgrade options for your parasols:



GLOW LED LIGHT P6/P7

We are pleased to introduce our new GLOW LED Light. The aluminium fixture with a glass bulb elevates the design. Moreover, the GLOW LED can easily be retrofitted, ensuring flexibility.

Flexible Power Options:

- Net Supply: powered by a transformer for AC100-265V.
- Battery System:



INTEGRATED LED LIGHTS P8

The integrated white LED light within the spokes provides a warm and elegant lighting solution.



HEATERS P6/P7/P8

Integrated 1500W heaters for comfort and warmth during cooler days.

The picture shown is for the P8 model



PROTECTION COVER P6/P7/P8

High-quality marine quality protection cover to extend the lifespan of your parasol.



RAINGUTTERS P6/P7/P8

Our rain gutters allow you to interconnect different parasols, channeling water away to keep your terrace space dry and comfortable. Easy to add on, thanks to the prefitted zippers on the canopy, ensuring a quick setup.



PREMIUM CANOPY P6/P7/P8

Tweeted acrylic fabric for an extra touch of elegance. Contact our team for further information

MAINTENANCE & PRESENTATION PRODUCTS

CANOPY MAINTENANCE PRODUCT	PROSTOR GUARD 1L (PER 6 BOTTLES)	£ 215
	PROSTOR GUARD 5L (PER 3 BOTTLES)	£ 451
	PROSTOR CLEAN 1L (PER 6 BOTTLES)	£ 110
	PROSTOR CLEAN 5L (PER 3 BOTTLES)	£ 206
	PROSTOR REPAIR KIT FOR ACRYLIC FABRIC	£ 27
POLE & FRAME MAINTENANCE PRODUCT	SET OF 'TOUCH UP SPRAY' PAINT AEROSOLS (RAL 9007, 9005,9016 + PRIMER) PRICE PER SET	£ 67*
PRESENTATION TOOLS	DEMO PRESENTATION BOX SAMPLES OF P6, P7 AND P8 POLE SAMPLE OF ALUMINUM HINGE & SPOKES	£ 53*
	FABRIC SAMPLES CARD SAMPLE OF ACRYLIC FABRIC P6-P7-P8 SAMPLES OF OLEFIN FABRIC P2-P3-P4	£ 5*

* net price

Sliding Glass Wall Systems



Seeglass RUN

Seeglass RUN is a sliding Glass wall system with upper and lower aluminium profiles ideal for use in outdoor areas. It is a 10mm tempered glass sliding door system. Each panel slides behind each other and when closing a pick up point moves the glass along. A range of self closing or foot locks are available as well as key locks. Optional RAL colours on powder coated finish. For more information please ask for details.

Sliding Glass Wall Systems



Seeglass Habitat

Vertical adjusting sliding glass upper and lower fixed panel ideal for commercial or residential installations. Available in 4 height combinations and up to 2m width modules can be joined into straight or L shaped configurations. Options of floor fixings, flower tub or moveable with wheels.

Optional RAL colours on powder coated finish. For more information please ask for details.

Uhlmann Heavy Duty Umbrellas



Please ask for details, specifications, prices and brochure

Brustor Outdoor Living



B150 + B200 Louvered Roofs
B600 Cabrio Roofs



B300 Fabric Roof



BT Fabric Roofs

Please ask for information on Outdoor Living Systems & Sliding Glass Solutions (separate brochures are available) and contact us to find out about our referral scheme.

www.pergolasandshading.co.uk/trade

Demonstration material



Samples

- 1** SOLAR Fabrics Collection (Dickson)
1600192
- 2** Soltis 86, 88, 92, W96 and STAM
1600247
- 3** Sunworker (Dickson)
1600230
- 4** Soltis 86
1600202
- 5** Soltis 92
1600203
- 6** Swela Perla
1600228
- 7** Sergé 600 Collection
1600201
- 8** Sergé 1% Collection
Sergé 600 Blockout LUNAR
Sergé 600 Blockout SOLAR
1600222
- 9** Dickson Jacquards
1600232
- 10** Sattler All Weather
1600233
- 11** Orchestra max sample card
1600261
- 12** Standard colours Sun Protection
1600277



Awnings display



Compact display



Screen display



B25 Demo

- Demo case B50 B50XL**
1600214 £88 net
- Demo case ZIP Screen**
1600123 £116 net
- Demo case B24 Elite, B25 Elite, B27 Eite**
1600212 £116 net
- Demo case B126**
1600135 £88 net
- Demo case B1200**
1600186 £116 net
- Compact display B126**
1600006 £319 net
- Demo box 40cm B25**
1600078 £24net
- Demo box 40cm B27**
1600081 £24 net
- Demo box 40cm B35**
1600074 £24 net
- Demo box 40cm B50**
1600084 £24 net
- Demo awnings display**
1600193 £1898 net
- Display Screen**
1600216 £999 net

Terms and Conditions

1. Broadview Shading Solutions Ltd (the Company) will use its best endeavours to provide goods and/or services within a reasonable time/date referred to but shall not be responsible for any delay beyond its control whether arising from weather conditions/breakdown in services or supplies or howsoever.
2. Payment in full is due on delivery of the goods unless otherwise agreed or a Trade Account is in place. The company will exercise its statutory right to claim interest and compensation for debt recovery costs under the late payment legislation if payments are not made in accordance with these terms. Interest will be charged at 4% pa above the Bank Of England Base Rate in force at the time the payment was due, calculated on a daily basis.
3. Delivery Charges - all indicated delivery fees are for delivery to the business address on the account. Any delivery to residential addresses will incur additional fees depending on location. Over 6m lengths price on request.
4. Title to goods or materials supplied by the Company (whether installed or affixed to premises or vehicles or not) in accordance with this order shall pass to the customer on delivery upon payment in full by the customer for such goods (and the price of installation if appropriate).
5. By accepting delivery of these goods you agree to these Terms & Conditions in full, unless there exists a separate signed agreement between yourself and The Company.
6. All prices and descriptions in this document are subject to change without prior notice.
7. If an item is suspected of being delivered damaged or is obviously damaged or parts are claimed to be missing the item has to be unpacked and fully checked. Any damages or missing items are to be signed for by the customer as damaged or missing goods and reported to Broadview Shading Solutions Ltd. within 48 hours of receipt of goods in order to state a valid claim. All damages will be treated as a priority and the company will endeavour to handle promptly and with care. Following these guidelines a speedy solution will be offered. In the event of a damaged item needing replacement quickly the company may charge for the item and on return of the damaged item decide to credit the item or not as the case may be. In either eventuality the customer will be fully informed.

TO REPORT ANY DAMAGES WITH DELIVERIES:

1) Scan the QR Code below or on the package and go to the website.

2) Follow the instructions online complete the damage reporting form and upload a photo(s) of the damage.

Our team will be in touch as soon as possible.



WARRANTY

All articles have been tested by the manufacturer who guarantees every part for a period of 5yrs from date of purchase. (Somfy motors and Bruster Awnings – FIVE years). This warranty is valid if the defective part shows faults which can be directly attributed to a construction error or poor quality materials. All parts are guaranteed against failure during the first five years provided:

1. Proof of purchase is presented
2. The article has been installed following instructions provided.
3. Damage did not occur due to an accident, carelessness, storm, wind, water pooling or normal wear and tear.
4. The Company will not be responsible for any labour by third party.
5. Any labour provided by Broadview will be charged for accordingly.

Our returns procedure is as follows:

1. Inform The Company of the fault and if possible send a photograph of the defective item preferably in writing or by email to sales@broadview.co.uk.
2. We will consider whether spare parts are to be despatched or a collection of the goods is necessary.
3. Ask our office for a returns order reference tracking number prior to return.
4. The item, if found to be faulty, will be returned to you free of charge or in the case where a charge applies, you will be informed of this prior to work commencing.

* Please note LED lighting and heaters are warrantied for 2 years.

BROADVIEW DELIVERY CHARGES

Awnings or screens Up to 5m length = £98

Awnings or screens 5m to 5.8m length = £116

Awning above 5.8m length = Price on Application
 Special Transport arrangement

B128 Pergola or B128 XL Pergola
 = Price on Application

Awning fabric covers = £60



Broadview
Shading Solutions

TRADE PRICE LIST

(excluding VAT)

BRUSTOR[®]
OUTDOOR SUN SYSTEMS

EXPERT

somfy.

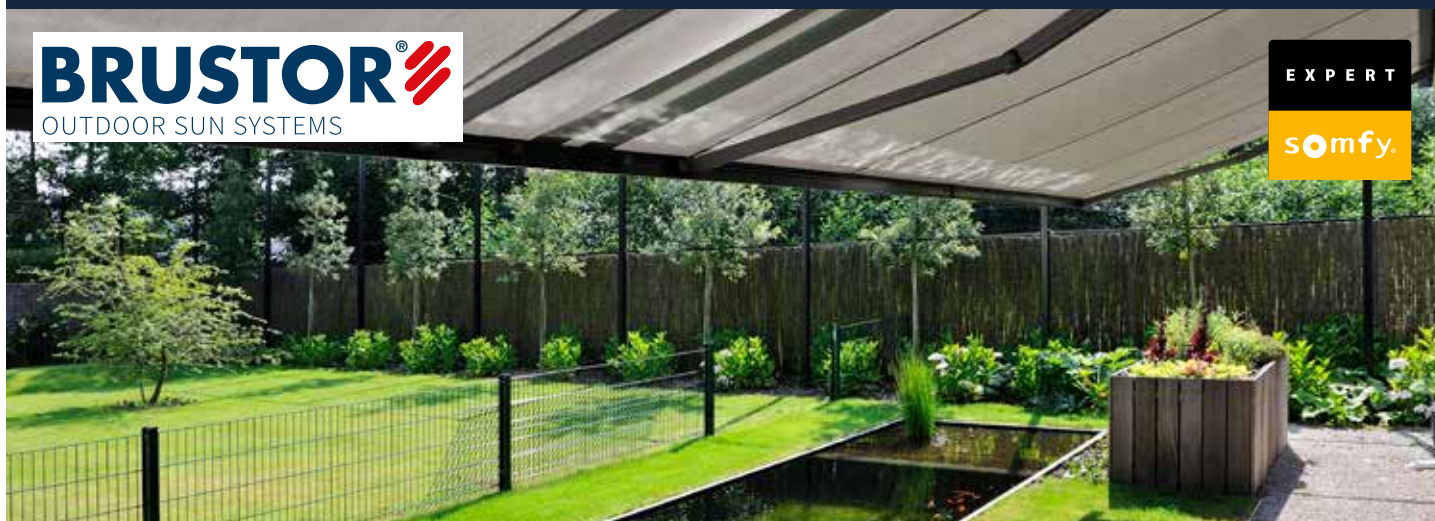

Factory Head Office
57 Hatchpond Road
Nuffield Ind. Est.
Poole
Dorset
BH17 0JZ

Tel: 01202 679012
Fax: 01202 671885

FOR TRADE SALES CONTACT:

Email: sales@broadview.co.uk

01202 679012

www.pergolasandshading.co.uk/trade

