

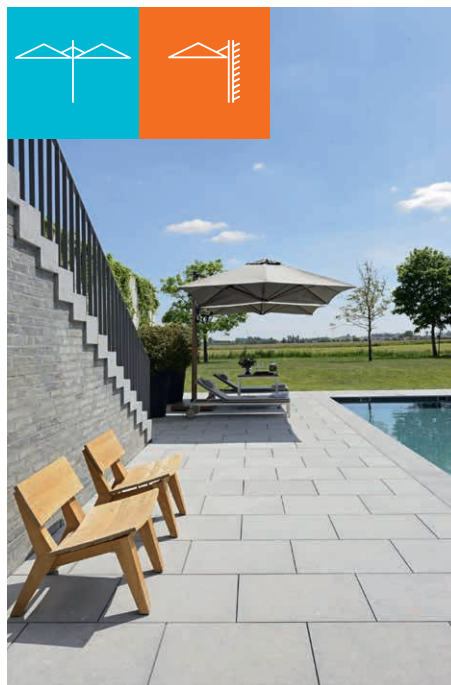

**PROSTOR<sup>®</sup>**   
SHADE SOLUTIONS

**Embrace the  
sun with our  
smart solutions**

# index



**PROSTOR P6**  
Side pole parasol &  
wall-mounted parasol

**page 8**



**PROSTOR P7**  
Side pole parasol &  
wall-mounted parasol

**page 20**



**PROSTOR P8**  
Central pole parasol

**page 32**



**PROSTOR P2**  
Central pole parasol

**page 42**



**PROSTOR P3 & P4**  
Wall-mounted  
telescopic arm parasol

**page 52**

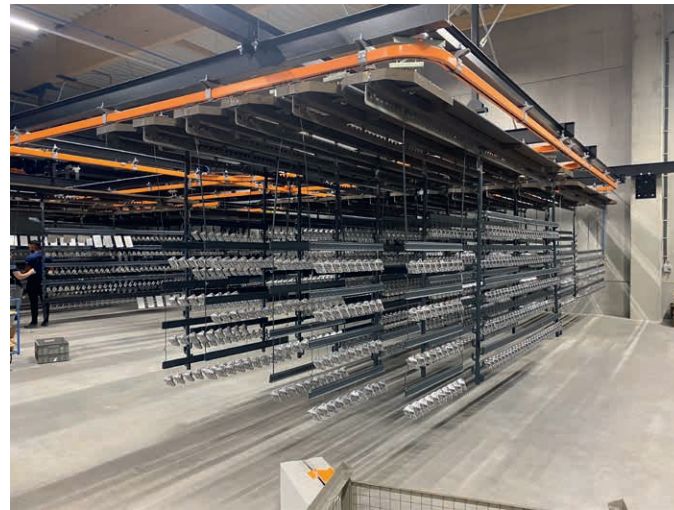

# prologue

Discover Prostor, a family-owned company with 50 years of expertise in sun protection. We celebrate **20 years** of Prostor, providing top-quality umbrellas with user-friendly design for both commercial and residential use.

Our commitment to quality and style brings a wealth of expertise to your terrace or garden, ensuring that our products are functional and visually appealing.

We take pride in offering a range of products that embody Belgian craftsmanship, ease of use, and durability. All of our products are made in Belgium by a skilled and passionate team and sold through a network of dealers and distributors who understand the market.

Join us in experiencing the best in stylish and user-friendly design and Belgian quality with Prostor.



# side pole umbrella

## PROSTOR P6

The Prostor P6 is a highly functional and modular parasol with up to 38 m<sup>2</sup> coverage. The pole can support up to 4 parasols and opens in 5 seconds. Equipped with heating and LED lighting, it's suitable for hospitality and private use. Featherlight to use, the P6 can be mounted on a wall and offers everlasting sun protection.

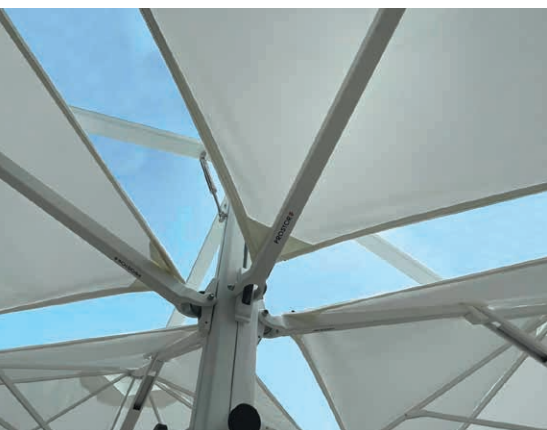







# features

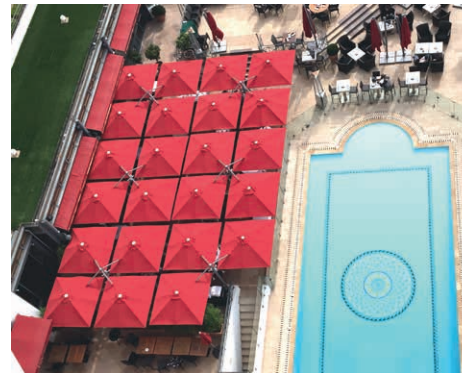

## Endless shade pleasure

One umbrella system can cover an area of up to 38 m<sup>2</sup>, allowing you to cover sizable terraces while minimizing the loss of valuable space, all while maintaining a stylish aesthetic.



## Up to 4 parasols on one pole

The Prostor P6 is a highly functional and modular parasol with up to 38 m<sup>2</sup> coverage. The P6 is suitable for hospitality and private use.



## Durable alu parts

We guarantee everlasting sun pleasure thanks to the durable aluminum parts. All parts are individually replaceable.



## Easy opening in 5 seconds

You don't have to be strong to operate the P6 umbrella. The patented One Move System helps you to open or close the umbrella easily in one movement. The umbrellas are featherlight to handle, thanks to the stainless steel gas spring.



## Option wall-mounted for optimal space use

Our umbrellas can be easily mounted on the wall freeing up valuable space on your terrace for extra tables and seats. When closed the umbrella is nicely stored against the wall.



## Opening above the table

No need to move the table while closing or opening the umbrella. The umbrella opens or closes above standard tables and chairs.

# PROSTOR P6

## DIMENSIONS

SCAN QR CODE  
FOR PRODUCT  
VIDEO



**P6 UNO SQR** 2,50 x 2,50 m

**DUO SQR** 2,50 x 5,15 m

**TRIO SQR** 5,15 x 5,15 m

**QUATTRO SQR** 5,15 x 5,15 m

**UNO RND** 3,50 m

**DUO RND** 3,50 x 7,15 m

6,25 m<sup>2</sup> up to 26,5 m<sup>2</sup>

**P6 XL UNO SQR** 3,00 x 3,00 m

**DUO SQR** 3,00 x 6,15 m

**TRIO SQR** 6,15 x 6,15 m

**QUATTRO SQR** 6,15 x 6,15 m

**UNO RND** 4,20 m

**DUO RND** 4,20 x 8,55 m

6,25 m<sup>2</sup> up to 38 m<sup>2</sup>

**P6 WALL UNO SQR** 2,50 x 2,50 m

**DUO SQR** 2,50 x 5,15 m

**P6 WALL XL UNO SQR** 3,00 x 3,00 m

**DUO SQR** 3,00 x 6,15 m

## COLOURS FRAME & POLE

**GREY TEXTURED COATING** RAL 9007

**WHITE TEXTURED COATING** RAL 9016

**BLACK TEXTURED COATING** RAL 9005

**COPPER** copper tint anodization

**POLISHED** silver tint anodization

# PROSTOR P6

## COLOURS FABRIC

### STANDARD RANGE

natural white white sand butter cup terra cotta paris red lead grey

taupe carbon grey night blue black widow olive green

**acryl** 100% solution-dyed

**weight** 290g/m<sup>2</sup>

**colourfastness** 7-8 / 8 (standard ISO 105 B04)

**waterproof** >300 mm water column

**maintenance** all fabric can be washed and replaced

### PREMIUM RANGE

tweed shell tweed black

tweed grey tweed toast

**acryl** 100% solution-dyed

**weight** 320g/m<sup>2</sup>

**colourfastness** 7-8 / 8 (standard ISO 105 B04)

**waterproof** >360 mm water column

**maintenance** all fabric can be washed and replaced

## ACCESSORIES

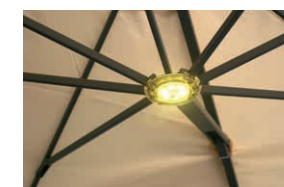

LED white



coloured LED (RGB)



electric IR heating

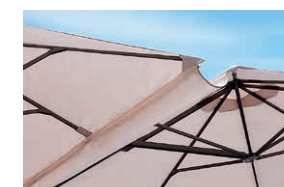

rain gutter



deluxe protection cover



printing of canopy

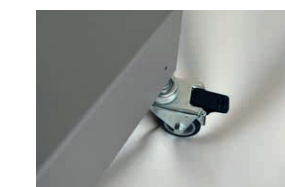

swivel wheels only for P6 UNO

## FIXATIONS

**GROUND ANCHOR**

**FLOOR PLATE**

**FLOOR PLATE**

**STEEL BASE**

**STEEL BASE**

**2 BRACKETS**

### GROUND ANCHOR

Adjustable ground anchor. Recommended to align multiple sets, it gives you up to 15° tolerance to the left and right.

### FLOOR PLATE

50 x 70 cm. Must be chemically anchored.

### FLOOR PLATE

70 x 70 cm. Must be chemically anchored.

### STEEL BASE

80 x 80 x 12 cm. With 12 tiles: 200 kg. Does not include tiles.

### STEEL BASE

100 x 100 x 10 cm. With 8 tiles: 270 kg. Does not include tiles.

### 2 BRACKETS

The P6 pole can be mounted on the wall with 2 brackets, providing sun protection without the pole or steel base being in the way. This feature is not available for the Round (RND) version.

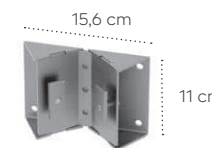



# side pole umbrella

## PROSTOR P7

The Prostor P7 is a durable and elegant parasol that rotates up to 300°. It features a simple One Move system for easy opening and closing with minimal effort. Ideal for private use, it can also be mounted on a wall.









# features



## Shade each time of the day

With the ability to rotate 300°, the P7 is designed to offer shade coverage throughout the day. Additionally, the small axle feature secures the umbrella in place, preventing any spinning caused by wind.



## Up to 15 m<sup>2</sup> of shade pleasure

The P7 model, whether in round or square shape, provides a shade coverage of up to 15 m<sup>2</sup>, ensuring maximum pleasure and comfort.



## Durable alu parts

We guarantee everlasting sun pleasure thanks to the durable aluminum parts. All parts are individually replaceable.



## Easy opening in 5 seconds

You don't have to be strong to operate the P7 umbrella. The patented One Move System helps you to open or close the umbrella easily in one movement. The umbrellas are featherlight to handle, thanks to the stainless steel gas spring.



## Option wall-mounted for optimal space use

The P7 pole can also be fitted to the wall with two 'rotating' brackets. By following the sun you can choose where you want shade easily, whatever time of the day. The P7 wall umbrella is designed to turn optimally when mounted on a corner. A small axle locks the umbrella into place and prevents it from spinning with the wind.



## Opening above the table





No need to move the table while closing or opening the umbrella. The umbrella opens or closes above standard tables and chairs.

# PROSTOR P7

SCAN QR CODE  
FOR PRODUCT  
VIDEO

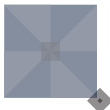

## DIMENSIONS

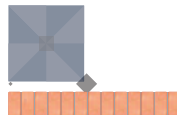
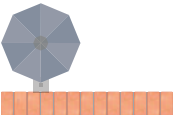
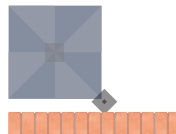
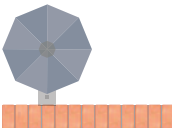
<b>P7</b>	<b>UNO SQR</b> 2,50 x 2,50 m	<b>UNO RND</b> 3,50 m	<b>P7 XL</b>	<b>UNO SQR</b> 3,00 x 3,00 m	<b>UNO RND</b> 4,20 m
					
<b>P7 WALL</b>	<b>UNO SQR</b> 2,50 x 2,50 m	<b>UNO RND</b> 3,50 m	<b>P7 WALL XL</b>	<b>UNO SQR</b> 3,00 x 3,00 m	<b>UNO RND</b> 4,20 m
					

## COLOURS FRAME & POLE

	<b>GREY TEXTURED COATING</b> RAL 9007		<b>WHITE TEXTURED COATING</b> RAL 9016		<b>BLACK TEXTURED COATING</b> RAL 9005		<b>COPPER</b> copper tint anodization
---	--	---	---	---	---	---	--

# PROSTOR P7

## COLOURS FABRIC

### STANDARD RANGE

					
natural white	white sand	butter cup	terra cotta	paris red	lead grey
					
taupe	carbon grey	night blue	black widow	olive green	





**acryl** 100% solution-dyed  
**weight** 290g/m<sup>2</sup>  
**colourfastness** 7-8 / 8 (standard ISO 105 B04)  
**waterproof** >300 mm water column  
**maintenance** all fabric can be washed and replaced

### PREMIUM RANGE







	
tweed shell	tweed black
	
tweed grey	tweed toast

**acryl** 100% solution-dyed  
**weight** 320/m<sup>2</sup>  
**colourfastness** 7-8 / 8 (standard ISO 105 B04)  
**waterproof** >360 mm water column  
**maintenance** all fabric can be washed and replaced

## ACCESSORIES

		
LED white	coloured LED (RGB)	
		
electric IR heating	deluxe protection cover	swivel wheels

## FIXATIONS

					
<b>GROUND ANCHOR</b> Adjustable ground anchor	<b>FLOOR PLATE</b> 50 x 70 cm Must be chemically anchored	<b>FLOOR PLATE</b> 70 x 70 cm Must be chemically anchored	<b>STEEL BASE</b> 80 x 80 x 12 cm With 12 tiles: 200 kg Does not include tiles	<b>STEEL BASE</b> 100 x 100 x 10 cm With 8 tiles: 270 kg Does not include tiles	<b>WALL BRACKETS</b> Rotating top & bottom brackets, inclusive pole



# central pole umbrella

## PROSTOR P8

The Prostor P8 is a large and stylish outdoor shade solution. It has an elegant and functional design, including a dimmable LED light and heating. The P8 is featherlight to operate, opens in 5 seconds, and is perfect for those who think big. Embrace the sun with the Prostor P8 parasol.







# features



## Integrated LED Lights

The integrated white LED light within the spokes provides a warm and elegant lighting solution.



## Durable alu parts

We guarantee everlasting sun pleasure thanks to the durable aluminum parts. All parts are individually replaceable.



## Easy opening in 5 seconds

You don't have to be strong to operate the P8 umbrella. The One Move System helps you to open or close the umbrella easily in one movement. Thanks to the well-balanced weight, the umbrellas are effortless to handle.



## Opening above the table

No need to move the table while closing or opening the umbrella. The umbrella opens or closes above standard tables and chairs.

# PROSTOR P8

SCAN QR CODE  
FOR PRODUCT  
VIDEO



## DIMENSIONS

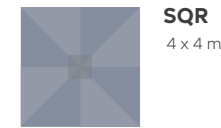

**SQR**  
4 x 4 m

## COLOURS FRAME & POLE



**GREY TEXTURED COATING**  
RAL 9007



## COLOURS FABRIC

### STANDARD RANGE



**acryl** 100% solution-dyed  
**weight** 290g/m<sup>2</sup>  
**colourfastness** 7-8 / 8 (standard ISO 105 B04)  
**waterproof** >300 mm water column  
**maintenance** all fabric can be washed and replaced

### PREMIUM RANGE



**acryl** 100% solution-dyed  
**weight** 320/m<sup>2</sup>  
**colourfastness** 7-8 / 8 (standard ISO 105 B04)  
**waterproof** >360 mm water column  
**maintenance** all fabric can be washed and replaced

## ACCESSORIES



dimmable LED light,  
integrated in the spokes



2 or 4 heaters per parasol.  
Heaters do not need to be  
removed when closing.



deluxe protection cover



rain gutter



printing of canopy

## FIXATIONS



**GROUND ANCHOR**  
Adjustable ground anchor  
Recommended to align  
multiple sets, it gives you  
up to 15° tolerance to the  
left and right.



**FLOOR PLATE**  
70 x 70 cm  
Must be chemically  
anchored



**STEEL BASE**  
80 x 80 x 12 cm  
With 12 tiles: 200 kg  
Does not include tiles



# central pole umbrella

## PROSTOR P2

The Prostor P2 parasol is the perfect choice for anyone seeking a timeless, yet contemporary design. Its lightweight design makes it easy to operate and move, making it ideal for use on terraces and in gardens. Whether you're looking for a stylish addition to your outdoor space or a functional solution for shade, the Prostor P2 is the perfect all-rounder.







# PROSTOR P2

## DIMENSIONS

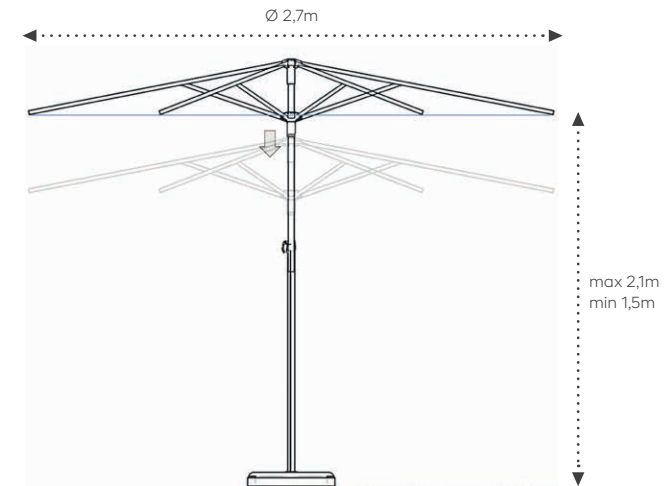

## COLOURS FRAME & POLE

ANODIZED ALUMINIUM



## COLOURS FABRIC

### STANDARD RANGE



**olefin** 100% solution-dyed

**weight** 190g/m<sup>2</sup>

**colourfastness** 7-8 / 8

**water repellent**

**maintenance** all fabric can be washed and replaced

## ACCESSORIES



polyester protection cover  
standardly included



swivel wheels

## FIXATIONS



### CONCRETE BASE

45 x 45 cm  
Concrete base with  
telescopic pole



# wall-mounted umbrella

## PROSTOR P3-P4

The Prostor P3 and P4 are wall-mounted parasols that are perfect for those with limited space who want to make the most of their terrace or garden. Both models feature horizontal pivoting and an extendable arm for maximum sun protection, and are designed with ease-of use in mind.



# features



## Wall-mounted for optimal space use

Our wall-mounted P3-P4 umbrellas are the perfect solution for those who want to save space on their terrace. By eliminating the need for a parasol base, you can fully enjoy your outdoor area without any obstructions.



## Can swing horizontally

Our umbrellas pivot horizontally, providing even more flexibility and coverage options.



## Telescopic arm, extendable up to 1,8m

Use the adjustable arm of the umbrella to position it optimally and protect yourself from the sun all day long.



## Can be tilted

The parasol has the ability to tilt up to 10 degrees, allowing for protection against the glare of the low sun.



# PROSTOR P3 / P4

SCAN QR CODE  
FOR PRODUCT  
VIDEO  
>P3 >>P4

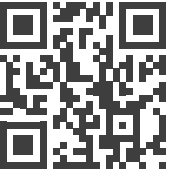
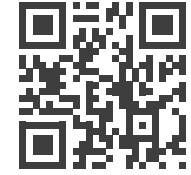

## DIMENSIONS

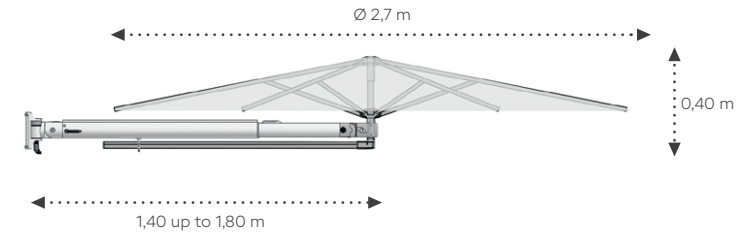

## COLOURS FRAME & POLE



ANODIZED ALUMINIUM

## COLOURS FABRIC

### STANDARD RANGE



**olefin** 100% solution-dyed

**weight** 190g/m<sup>2</sup>

**colourfastness** 7-8 / 8

**water repellent**

**maintenance** all fabric can be washed and replaced

## ACCESSORIES



polyester protection cover standardly included

## FIXATIONS



### WALL BRACKET P3

Height of 25 cm  
The P3 umbrella can be easily removed from the wall bracket



### WALL BRACKET P4

Height of 25 cm

**Prostor bv**

Belgium

T +32 (0)56 26 56 56

info@prostor.be

www.prostor.be

